

**eseo**<sup>®</sup>  
LIGHT FOR LIFE

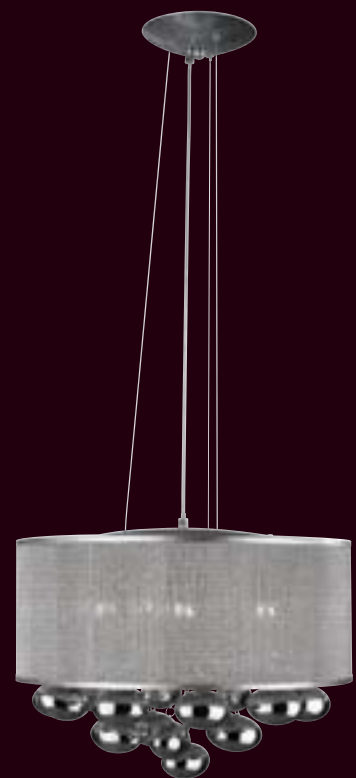

Collection 2012





**eseo**<sup>®</sup>  
LIGHT FOR LIFE





“Light for Life” is the lively and powerful brand promise that reflects the essence of Eseo. It is all about joy, emotion and that extra touch of flair needed to exceed mediocrity.

When the word “home” comes to mind, we all spontaneously think of a warm and welcoming place, a personal space with its own character and soul. It is clear: a home brings harmony into our lives, but what would it be without lighting?

To accomplish this harmony, the Eseo collection presents a rich and stylish assortment of fashionable and contemporary lighting products. The use of warm, textured materials feels welcoming and familiar. Shapes derived from cultures around the world add a touch of drama to compose your own style. Emphasized by glowing light effects and creative illumination, it will turn your home into an inspiring and personal place.

Eseo embraces you with a sense of belonging and feel good.

**E**xciting designs

**S**tyle richness

**E**volving assortment

**O**ptimal harmony in your home



- Decorative lighting	4
- Wall & ceiling	53
- Floor lamps	101
- Table lamps	110
- Spots	112



Warning:  
This is more  
than a table!

## “SWITCH IT ON”

Choose your preferred light colour  
and enjoy the soft indirect light,  
the marriage of furniture and lighting  
for your convenience.

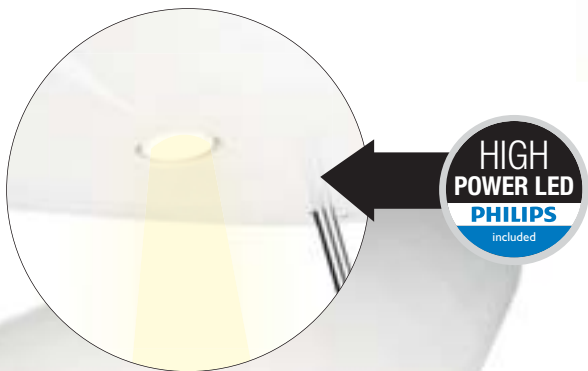

HIGH  
POWER LED  
PHILIPS  
included

80%  
energy  
saving

tunable  
white

120°  
beam angle

20  
years

## “TUNE YOUR LIGHT”

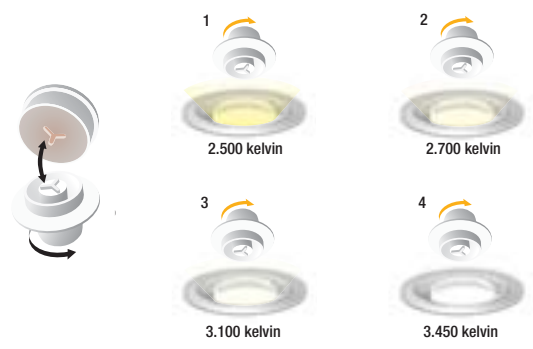





# Hyde

❶ 43231/30/13

❷ 43231/31/13

❸ 43231/32/13

1x PowerLED | max. 7,5W | 

1 557 / ↔ 566 / ↗ 518

 2 M



1→3



1→3





2

# Reicha

**1 37595/17/13**

9x G4 | max. 20W | 12V | ☉  
1500 / ↔ 927 / ↗ 321

**2 37596/17/13**

6x G4 | max. 20W | 12V | ☉  
279 / ↔ 748 / ↗ 318

**3 37597/17/13**

3x G4 | max. 20W | 12V | ☉  
1200 / ↔ 361 / ↗ 173

**4 37598/17/13**

6x G4 | max. 20W | 12V | ☐  
1757 / ↔ 467 / ↗ 312

**5 37599/17/13**

3x G4 | max. 20W | 12V | ☐  
1401 / ↔ 360 / ↗ 236



3



4→5



1→5

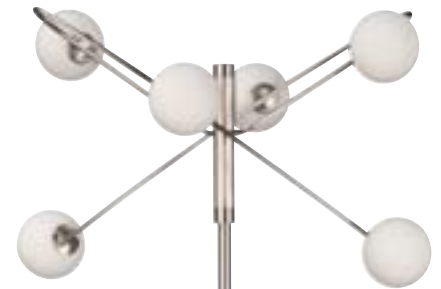
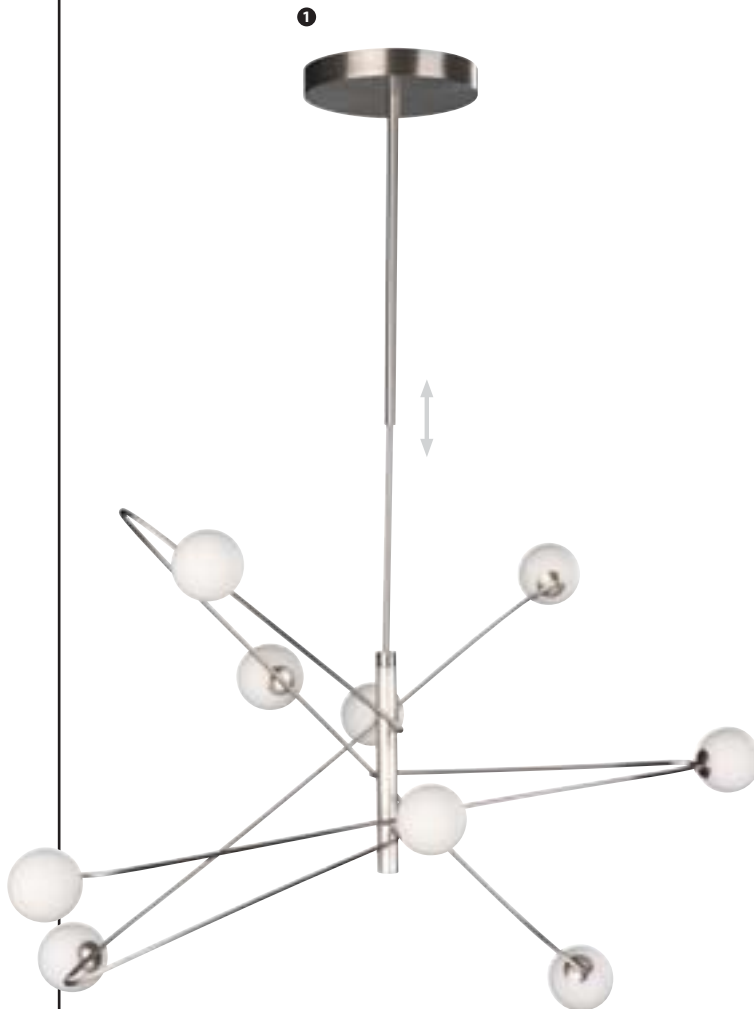

## Nanino

### ❶ 40671/17/13

6x G9 | max. 42W | 230V | Ⓢ  
↓ 1100 / ↔ 850 / ↗ 295

### ❷ 40672/17/13

6x G9 | max. 42W | 230V | Ⓢ  
T 120 / ↔ 1623 / ↗ 245

### ❸ 40673/17/13

3x G9 | max. 42W | 230V | Ⓢ  
T 140 / ↔ 995 / ↗ 230

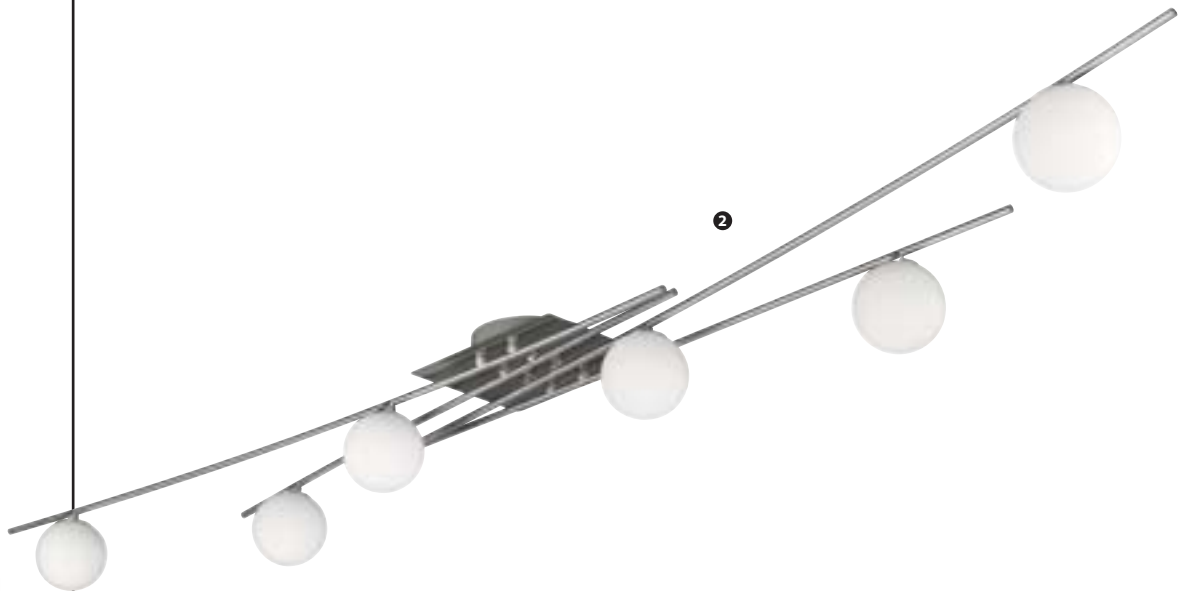

## Nanino

**1 40671/43/13**

6x G9 | max. 42W | 230V | Ⓢ  
I 1100 / ↔ 850 / ↗ 295

**2 40672/43/13**

6x G9 | max. 42W | 230V | Ⓢ  
T 120 / ↔ 1623 / ↗ 245

**3 40673/43/13**

3x G9 | max. 42W | 230V | Ⓢ  
T 140 / ↔ 995 / ↗ 230

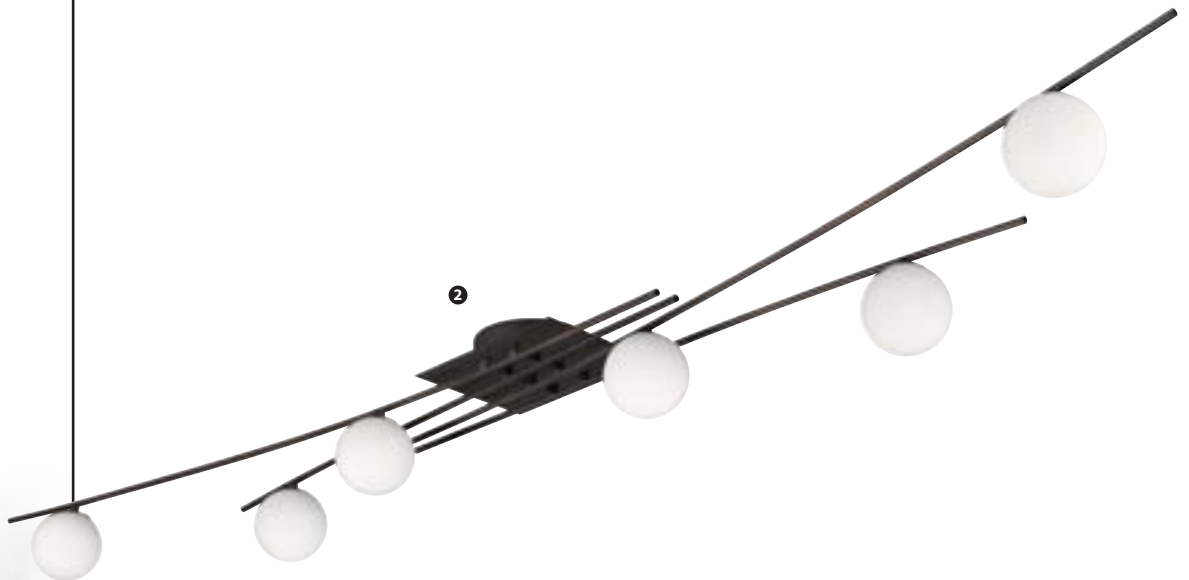



2

## Arvo

### ❶ 37811/17/13

3x E27 | max. 60W | 230V | Ⓢ

💡 18W incl.

↑ 1650 / ↔ 800 / ↘ 160

### ❷ 37812/17/13

1x E14 | max. 60W | 230V | Ⓢ

💡 11W incl.

↑ 300 / ↔ 155 / ↘ 120

### ❸ 37814/17/13

1x E14 | max. 60W | 230V | Ⓢ

💡 11W incl.

↑ 310 / ↔ 160 / ↘ 160



3



1



2+3



## Bozza

**1 40685/11/13**

1x E27 | max. 60W | 230V | ⊕  
↓ 1800 / ↔ 392 / ↗ 392

**2 40722/11/13**

1x E14 | max. 60W | 230V | ⊞  
↓ 1500 / ↔ 197 / ↗ 197

**3 43251/11/13**

1x E14 | max. 40W | 230V | ⊞  
↓ 215 / ↔ 200 / ↗ 270

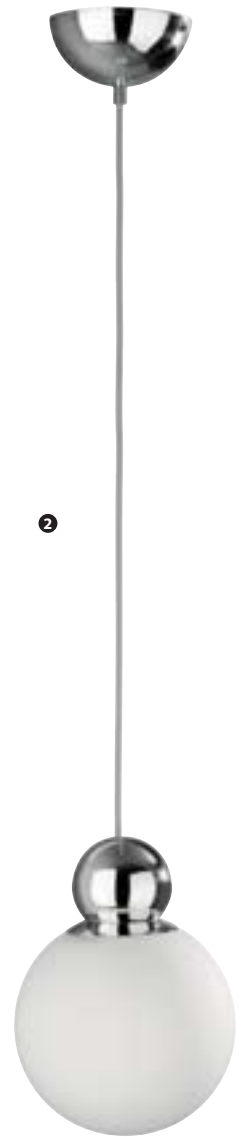
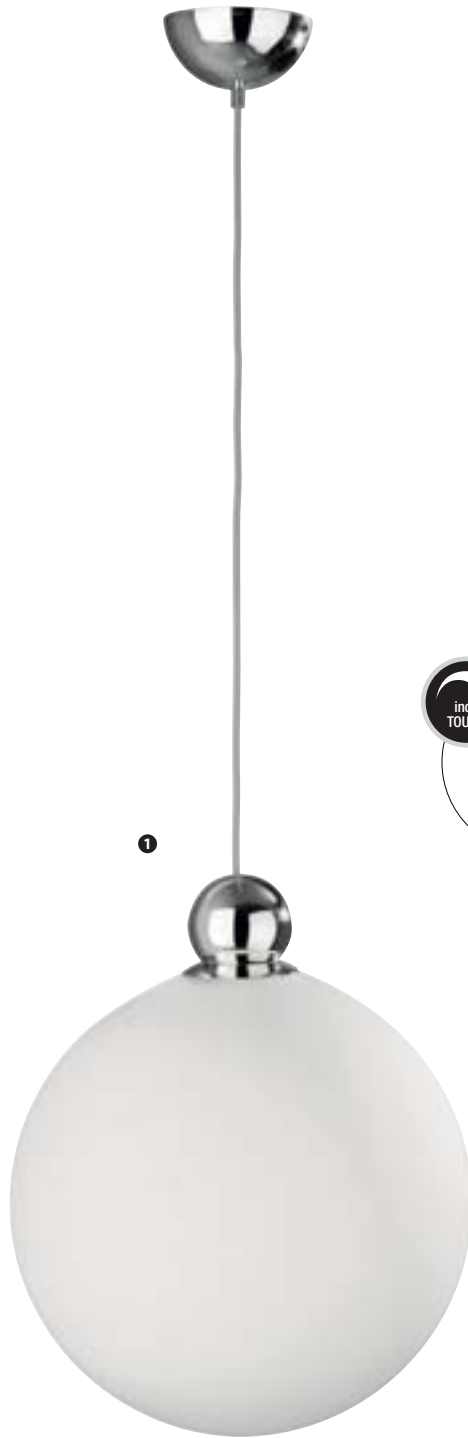



## Bozza

**1 40685/31/13**

1x E27 | max. 60W | 230V | ⊕  
↓ 1800 / ↔ 392 / ↗ 392

**2 40722/31/13**

1x E14 | max. 60W | 230V | ⊞  
↓ 1500 / ↔ 197 / ↗ 197

**3 43251/31/13**

1x E14 | max. 40W | 230V | ⊞  
↓ 215 / ↔ 200 / ↗ 270



1→3



## Batioli

**1 37586/11/13**

9x G4 | max. 20W | 12V | ☉  
↑ 1500 / ↔ 1200 / ↘ 290

**2 37588/11/13**

3x G4 | max. 20W | 12V | ☐  
↑ 1470 / ↔ 280 / ↘ 280

**3 37589/11/13**

3x G4 | max. 20W | 12V | ☐  
↑ 390 / ↔ 290 / ↘ 290



2→3



1→3



## Nikos

**1 40523/17/13**

1x GY 6,35 | max. 35W | 230V | ⊕  
↑ 2500 / ↔ 133 / ↙ 133

**2 40524/17/13**

3x GY 6,35 | max. 35W | 230V | ⊕  
↑ 1700 / ↔ 800 / ↙ 133



1→2

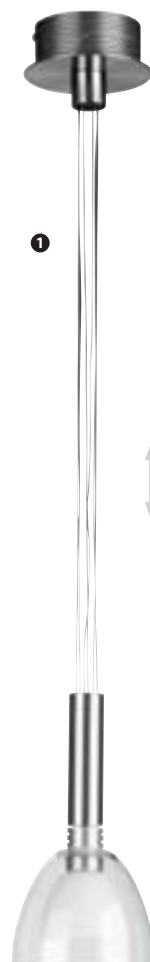



2

## Barnes

**1 40644/17/13**

1x GY 6,35 | max. 35W | 230V 12V | ☉  
↓ 1500 / ← 160 / ↗ 160

**2 40645/17/13**

3x GY 6,35 | max. 35W | 230V 12V | ☉  
↓ 1500 / ← 800 / ↗ 160

**3 40646/17/13**

3x GY 6,35 | max. 35W | 230V 12V | ☉  
↓ 1500 / ← 350 / ↗ 350



1→3





3

## Barnes

**1 40644/06/13**

1x GY 6,35 | max. 35W | 230V 12V | ☉  
↓ 1500 / ↔ 160 / ↗ 160

**2 40645/06/13**

3x GY 6,35 | max. 35W | 230V 12V | ☉  
↓ 1500 / ↔ 800 / ↗ 160

**3 40646/06/13**

3x GY 6,35 | max. 35W | 230V 12V | ☉  
↓ 1500 / ↔ 350 / ↗ 350

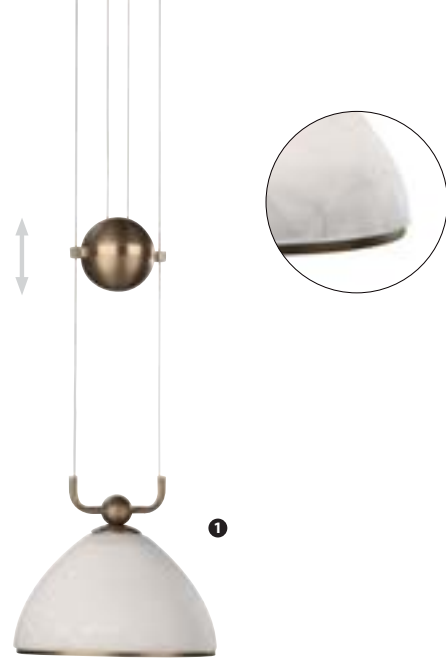





## Maximus

**1 37070/17/13**

3x G9 | max. 40W | 230V | ⊕  
T 140 / ↔ 470 / ↗ 470

**2 37071/17/13**

5x G9 | max. 40W | 230V | ⊕  
T 170 / ↔ 490 / ↗ 490

**3 40663/17/13**

5x G9 | max. 40W | 230V | ⊕  
T 1200 / ↔ 560 / ↗ 560



1→3



## Durabo

**1 37032/17/13**

2x G9 | max. 40W | 230V | ⊕  
I 362 / ↔ 190 / ↗ 100

**2 37034/17/13**

3x G9 | max. 40W | 230V | ⊕  
I 520 / ↔ 190 / ↗ 190

**3 37036/17/13**

7x G9 | max. 25W | 230V | ⊕  
T 80 / ↔ 400 / ↗ 400



1→2



1→3



3



1



2

## Durabo

**1 37030/17/13**

8x G9 | max. 25W | 230V | Ⓢ  
1 900 / ↔ 610 / ↗ 610

**2 37031/17/13**

7x G9 | max. 25W | 230V | Ⓢ  
T 100 / ↔ 600 / ↗ 600

**3 37033/17/13**

5x G9 | max. 40W | 230V | Ⓢ  
1 1710 / ↔ 250 / ↗ 250



3



1→3



# Stream

**1 37846/17/13**

6x E14 | max. 40W | 230V | ⊕  
T 135 / ↔ 790 / ↗ 360

**2 37848/17/13**

2x E14 | max. 40W | 230V | ⊕  
I 1460 / ↔ 220 / ↗ 390

 Fit for energy saving lamps



2



## Stream

**1 37845/17/13**

5x E14 | max. 40W | 230V | Ⓢ  
↑ 1575 / ↔ 600 / ↗ 600

**2 37847/17/13**

1x E14 | max. 40W | 230V | Ⓢ  
↑ 350 / ↔ 125 / ↗ 130

**3 37849/17/13**

1x E14 | max. 40W | 230V | Ⓢ  
↑ 450 / ↔ 150 / ↗ 150

 Fit for energy saving lamps



2



3





5

1

## Stream

**1 37845/43/13**

5x E14 | max. 40W | 230V | ⊕  
↓ 1575 / ↔ 600 / ↗ 600

**2 37846/43/13**

6x E14 | max. 40W | 230V | ⊕  
T 135 / ↔ 790 / ↗ 360

**3 37847/43/13**

1x E14 | max. 40W | 230V | ⊕  
↓ 350 / ↔ 125 / ↗ 130

**4 37848/43/13**

2x E14 | max. 40W | 230V | ⊕  
↓ 1460 / ↔ 220 / ↗ 390

**5 37849/43/13**

1x E14 | max. 40W | 230V | ⊕  
↓ 450 / ↔ 150 / ↗ 150

 Fit for energy saving lamps



3



4+5



2



4



3







## Sierra

**1 40647/11/13**

12x G4 | max. 20W | 230V 12V | ☉  
H 1100 / → 830 / ↗ 830

**2 40648/11/13**

10x G4 | max. 20W | 230V 12V | ☉  
H 1100 / → 920 / ↗ 510

**3 40649/11/13**

8x G4 | max. 20W | 230V 12V | ☉  
T 195 / → 1000 / ↗ 405



1→3



2



## Sierra

**1 40647/86/13**

12x G4 | max. 20W | 12V |   
↓ 1100 / ↔ 830 / ↗ 830

**2 40648/86/13**

10x G4 | max. 20W | 12V |   
↓ 1100 / ↔ 920 / ↗ 510

**3 40649/86/13**

8x G4 | max. 20W | 12V |   
T 195 / ↔ 1000 / ↗ 405



1→3



## Bencini

**1 40665/11/13**

4x GY 6,35 | max. 35W | 220-240V | 50/60Hz  
H 1740 / W 905 / A 90

**2 40666/11/13**

6x GY 6,35 | max. 35W | 220-240V | 50/60Hz  
H 1740 / W 1105 / A 90



1→2

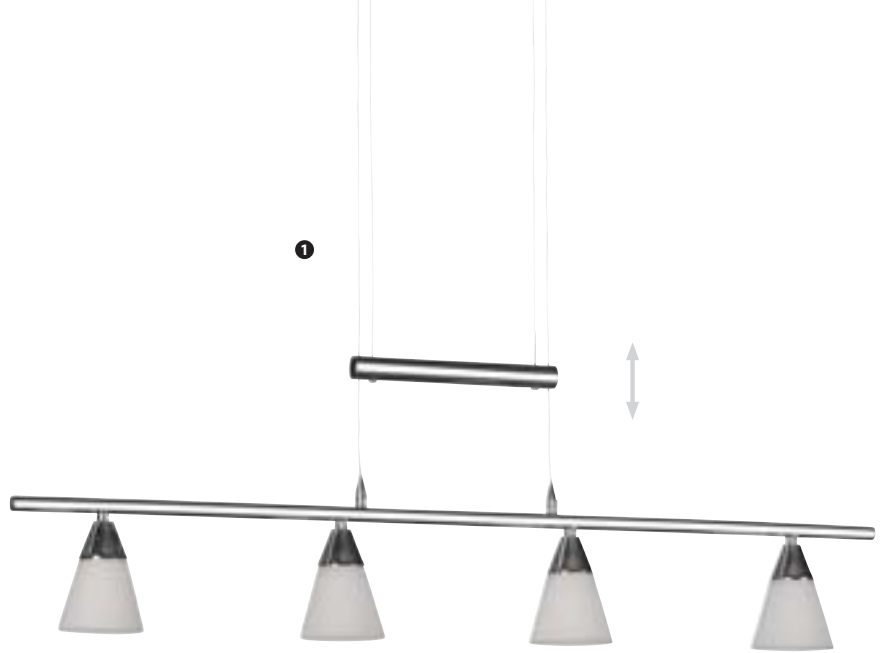

## Bencini

**1 40683/43/13**

6x GY 6,35 | max. 35W | 230V 12V | ⊕  
↓ 1760 / ← 1105 / ↗ 90

**2 40684/43/13**

4x GY 6,35 | max. 35W | 230V 12V | ⊕  
↓ 1760 / ← 905 / ↗ 90



1→2



# Enzo

**1 40525/11/13**

7x G4 | max. 20W | 12V | Ⓢ  
1 2570 / ← 900 / ↗ 83

**2 40526/11/13**

7x G4 | max. 20W | 12V | Ⓢ  
1 1500 / ← 350 / ↗ 350



1→2



## Vitali

**1 37570/60/13**

5x G9 | max. 40W | 230V | Ⓢ  
1 900 / ↔ 733 / ↗ 100

**2 37571/60/13**

8x G9 | max. 40W | 230V | Ⓢ  
1 900 / ↔ 600 / ↗ 290

**3 37573/60/13**

4x G9 | max. 40W | 230V | Ⓢ  
T 95 / ↔ 250 / ↗ 250



1→3

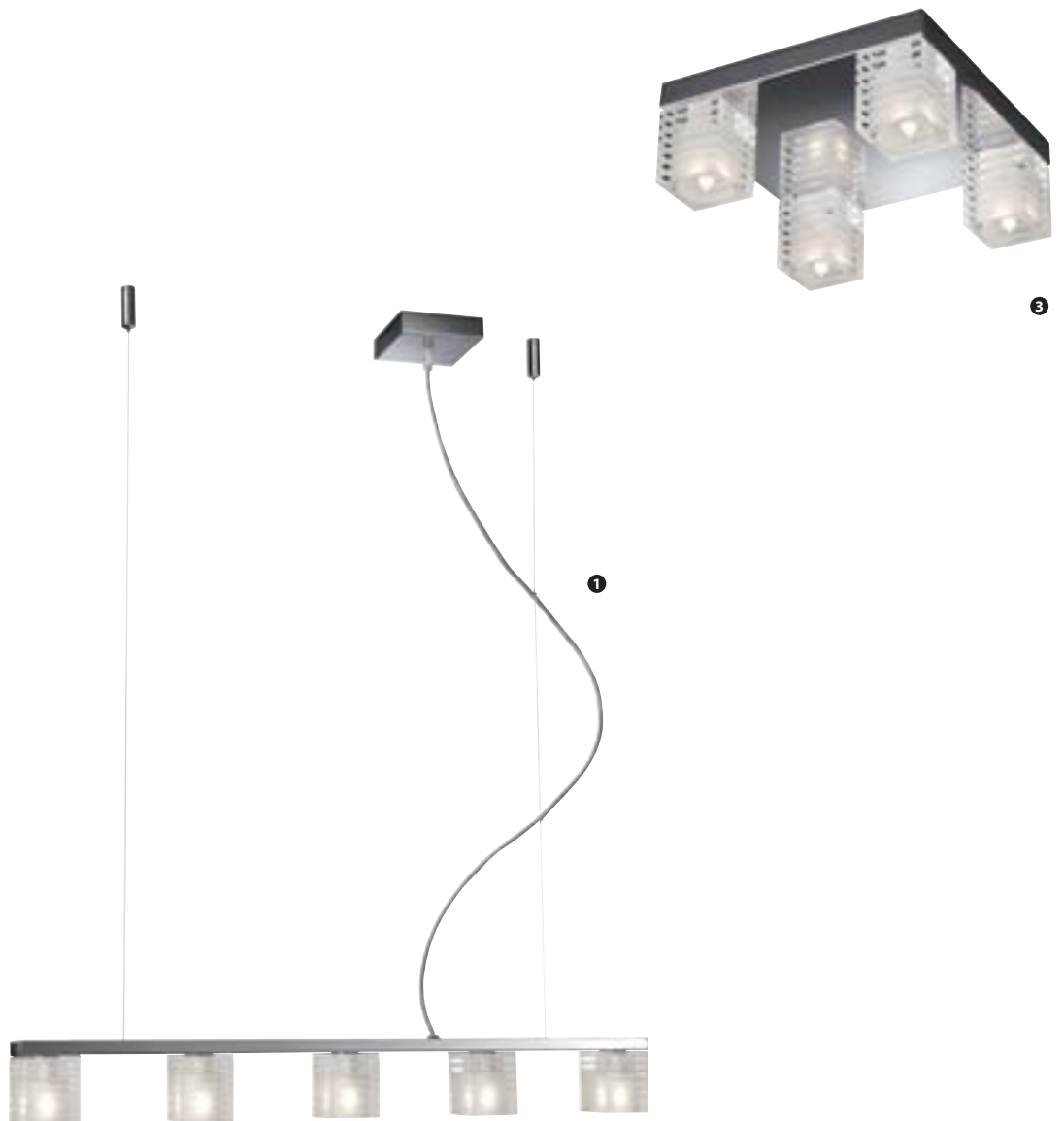

## Monti

**1 37425/11/13**

6x G9 | max. 40W | 230V | Ⓢ  
↑ 1400 / ↔ 753 / ↘ 345

**2 37427/11/13**

1x G9 | max. 40W | 230V | Ⓢ  
↑ 150 / ↔ 160 / ↘ 160



1→2

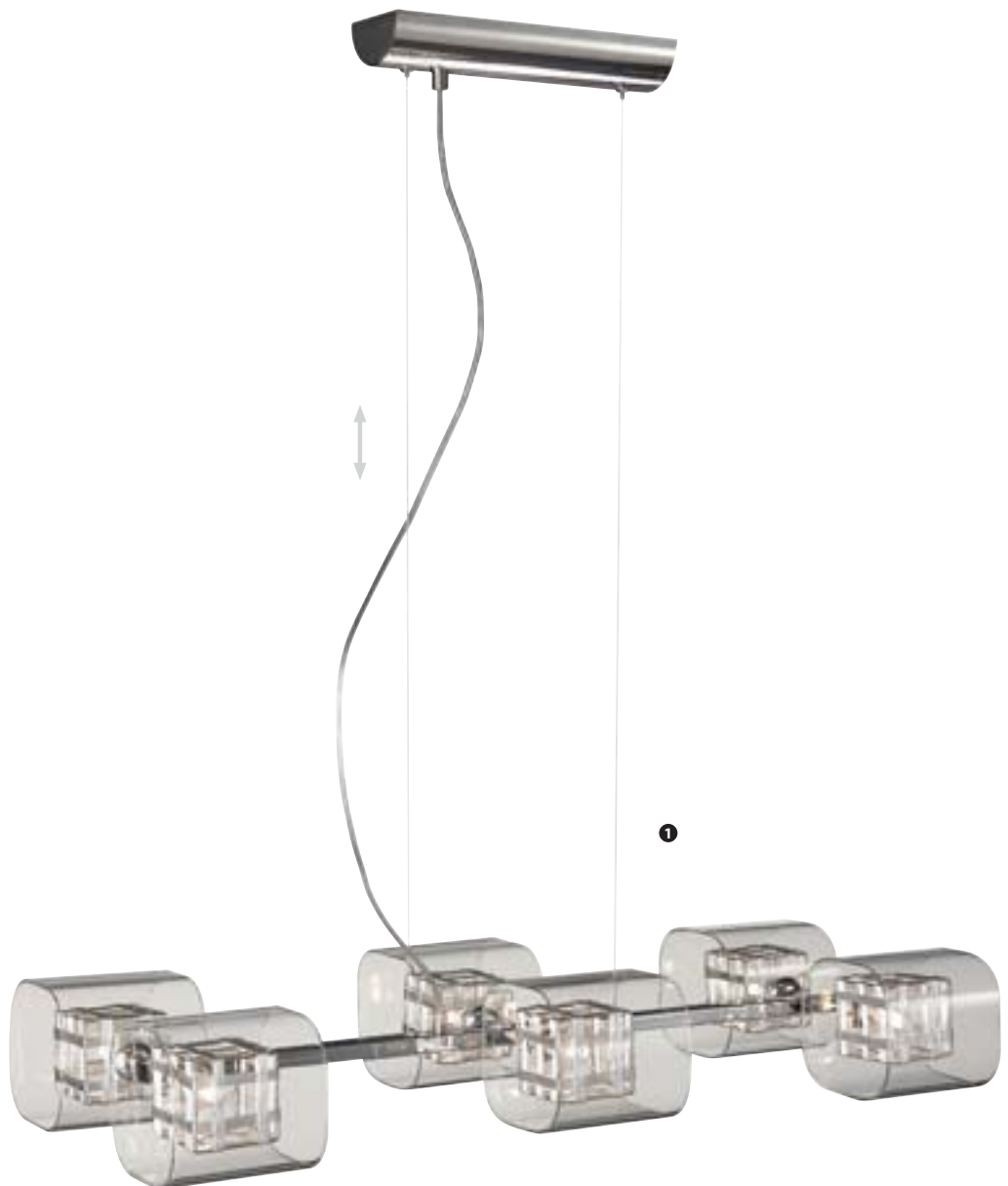



## Monti

**1 37428/11/13**

4x G9 | max. 40W | 230V | □  
↑ 1620 / ↔ 220 / ↗ 260

**2 37429/11/13**

1x G9 | max. 40W | 230V | □  
↑ 335 / ↔ 125 / ↗ 145



1



2



1→2



## Stradella

❶ 40394/11/13

22x G4 | max. 10W | 230V-12V | ⊕

↑ 970 / ↔ 640 / ↗ 640

## Cara

❷ 40431/17/13

6x G4 | max. 20W | 230V-12V | ⊕

↑ 1565 / ↔ 1100 / ↗ 123



1→2



## Belfiore

### ❶ 37815/11/13

12x G4 | max. 20W | 230V 12V | ⊕  
H 1200 / → 500 / ↗ 500

### ❷ 37816/11/13

10x G4 | max. 20W | 230V 12V | ⊕  
T 255 / → 400 / ↗ 400

### ❸ 37818/11/13

10x G4 | max. 20W | 230V 12V | ⊕  
H 1400 / → 400 / ↗ 400



3



1→3

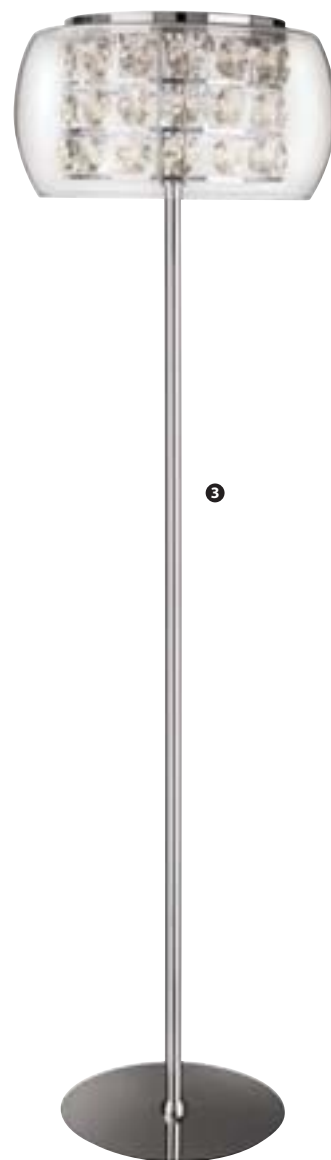
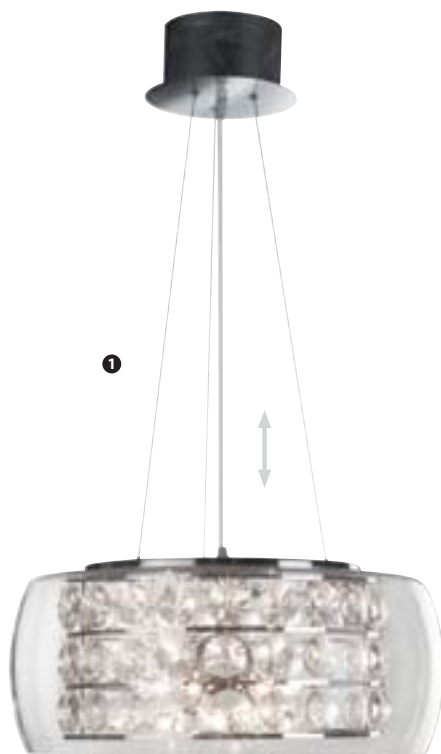

## Calixa

❶ 37426/11/13

5x GU10 | max. 50W | 230V | Ⓢ

↑ 610 / ↔ 400 / ↗ 400

## Grandi

❷ 40439/11/13

8x G9 | max. 42W | 230V | Ⓢ

↑ 1300 / ↔ 520 / ↗ 520

## Cocchi

❸ 40681/11/13

7x G9 | max. 42W | 230V | Ⓢ

↑ 1860 / ↔ 450 / ↗ 450

❹ 40682/11/13

7x G9 | max. 42W | 230V | Ⓢ

↑ 330 / ↔ 450 / ↗ 450



1



2-4

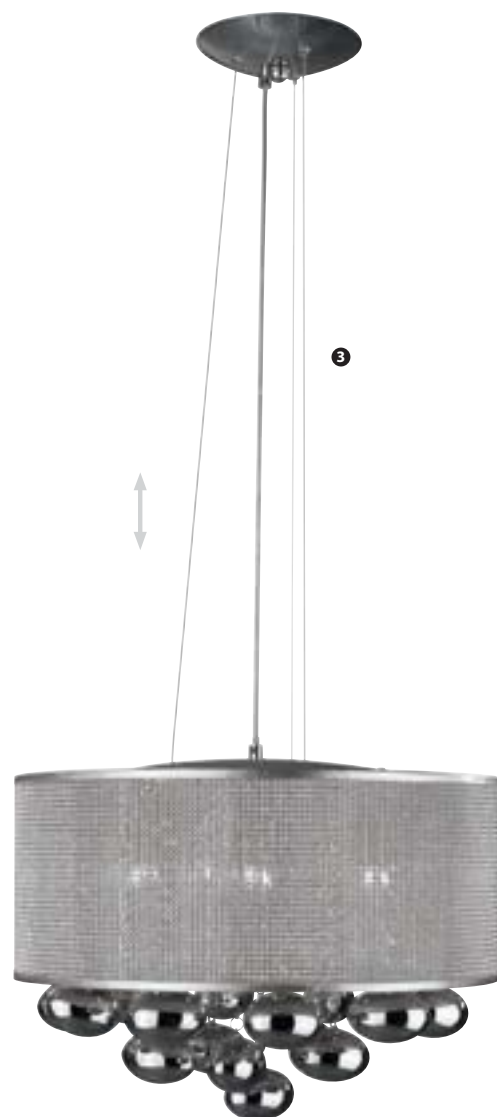





2

## Festa

❶ 37445/11/13

14x G4 | max. 10W | 230V 12V | ⊕  
↓ 1300 / ↔ 510 / ↗ 510

❷ 37448/11/13

9x G4 | max. 10W | 230V 12V | ⊕  
T 265 / ↔ 510 / ↗ 510

## Arino

❸ 40533/11/13

12x G4 | max. 20W | 230V 12V | ⊕  
↓ 1500 / ↔ 670 / ↗ 670

❹ 40534/11/13

6x G4 | max. 20W | 230V 12V | ⊕  
T 121 / ↔ 620 / ↗ 620



1→4

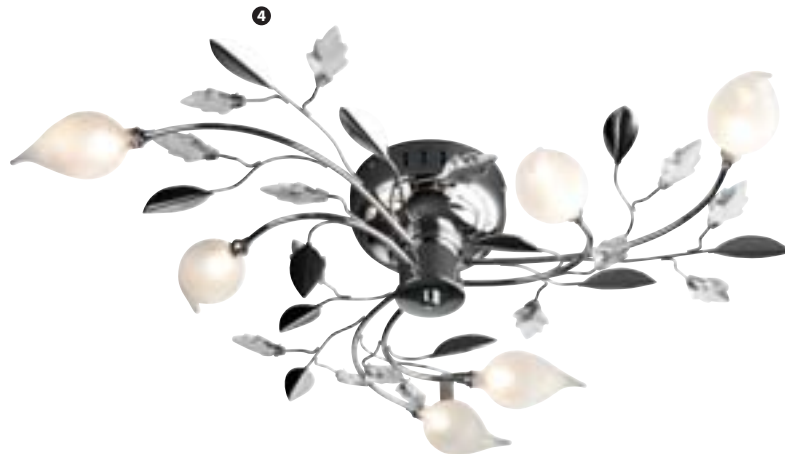
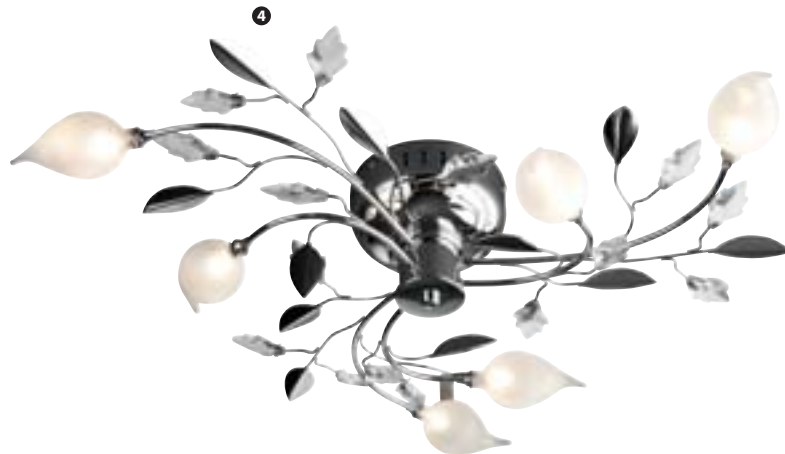





# Thor

**1 40527/11/13**

10x G4 | max. 20W | 12V | 回  
↓ 1500 / ← 560 / ↗ 560

**2 40528/11/13**

10x G4 | max. 20W | 12V | 回  
↓ 1500 / ← 830 / ↗ 600

**3 40529/11/13**

8x G4 | max. 20W | 12V | ⊕  
T 440 / ← 450 / ↗ 450



1→3



## Tuma

**1 40667/11/13**

6x G4 | max. 20W | 12V | Ⓢ  
1725 / ↔ 1220 / ↗ 250

**2 40668/11/13**

6x G4 | max. 20W | 12V | Ⓢ  
T 212 / ↔ 600 / ↗ 600

**3 40669/11/13**

3x G4 | max. 20W | 12V | Ⓢ  
T 195 / ↔ 415 / ↗ 415



1→3



## Erba

**1 37820/11/13**

8x G4 | max. 20W | 230V 12V | Ⓢ

T 150 / ↔ 635 / ↗ 715

**2 37821/17/13**

8x G4 | max. 20W | 230V 12V | Ⓢ

T 200 / ↔ 620 / ↗ 610



1→2



## Bellasio

**1 40674/11/13**

6x G4 | max. 20W | 12V | Ⓢ  
T 130 / ↔ 615 / ↗ 615

**2 40675/11/13**

9x G4 | max. 20W | 12V | Ⓢ  
T 140 / ↔ 700 / ↗ 700



1→2



## Bellasio

**1 40676/11/13**

9x G4 | max. 20W | 230V 12V | Ⓢ  
↑ 1000 / ↔ 770 / ↘ 770

**2 40677/11/13**

7x G4 | max. 20W | 230V 12V | Ⓢ  
↑ 740 / ↔ 1020 / ↘ 140



1→2





# Gabrieli

**1 40678/11/13**

6x G4 | max. 20W | 12V | Ⓢ  
26x LED | 230V  
T 170 / ↔ 670 / ↗ 670

**2 40679/11/13**

9x G4 | max. 20W | 12V | Ⓢ  
12x LED | 230V  
T 205 / ↔ 640 / ↗ 640

**3 40680/11/13**

8x G4 | max. 20W | 12V | Ⓢ  
42x LED | 230V  
T 205 / ↔ 450 / ↗ 450



1→3



1→3



1→3



1

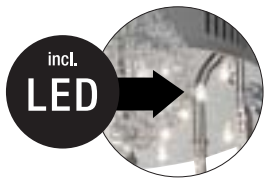

2

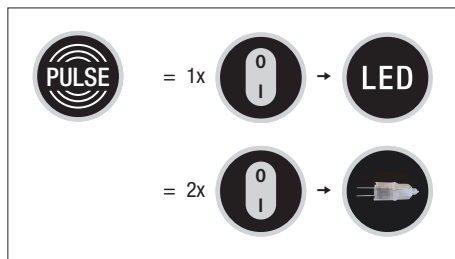

# Fontana

**1 40385/60/13**

4x G9 | max. 42W | 230V | Ⓢ  
T 400 / ↔ 380 / ↗ 380

**2 40386/60/13**

9x G9 | max. 42W | 230V | Ⓢ  
T 405 / ↔ 590 / ↗ 590



1→2





# Human

**1 37060/11/13**

5x G4 | max. 20W | 12V | Ⓢ  
T 120 / → 350 / ↗ 350

**2 37061/11/13**

8x G4 | max. 20W | 12V | Ⓢ  
T 130 / → 450 / ↗ 450



1→2



1



2

## Rossi

**1 37985/11/13**

16x G4 | max. 10W | 12V | ⊕  
T 90 / ↔ 400 / ↗ 400

**2 37986/11/13**

16x G4 | max. 10W | 12V | ⊕  
T 51 / ↔ 450 / ↗ 450

**3 37987/11/13**

6x G4 | max. 10W | 12V | ⊕  
↑ 155 / ↔ 177 / ↗ 60



1→3

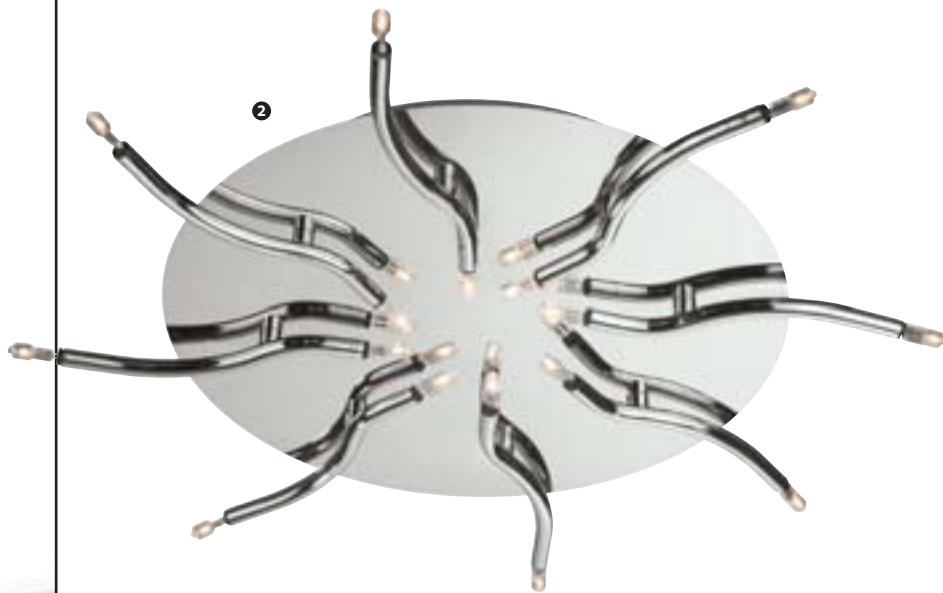
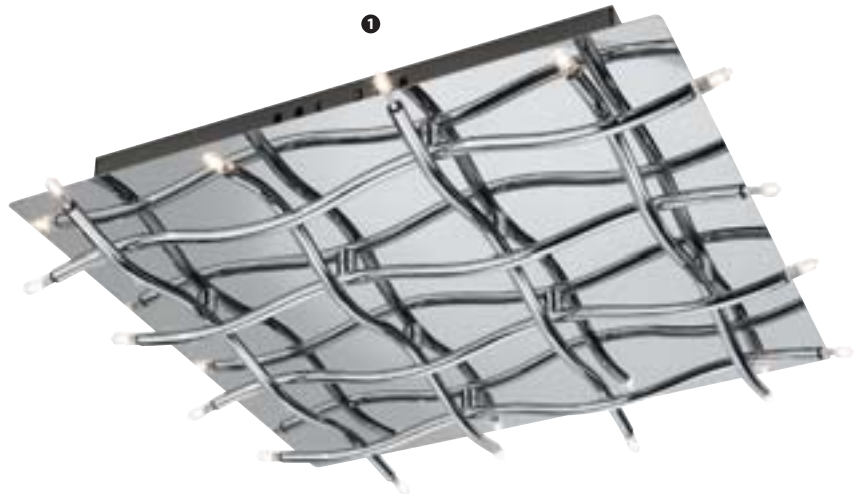

# Maduro

**1 37064/11/13**

10x G4 | max. 20W | 230V 12V | ⊕  
5x G4 | max. 10W | 230V 12V  
T 205 / ↔ 825 / ↗ 825

**2 37065/11/13**

10x G4 | max. 10W | 230V 12V | ⊕  
T 150 / ↔ 515 / ↗ 515

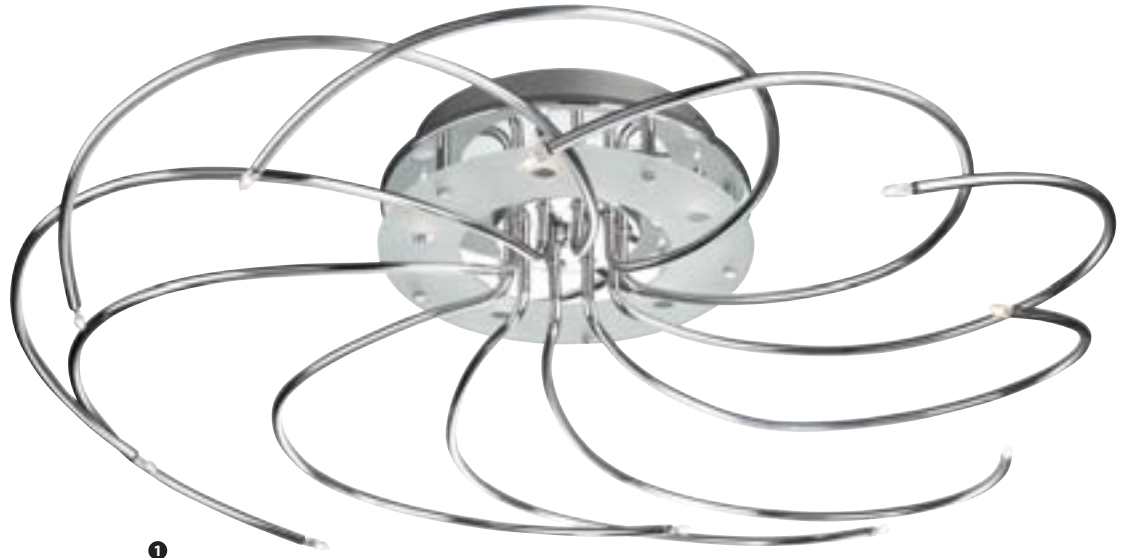

1



1→2

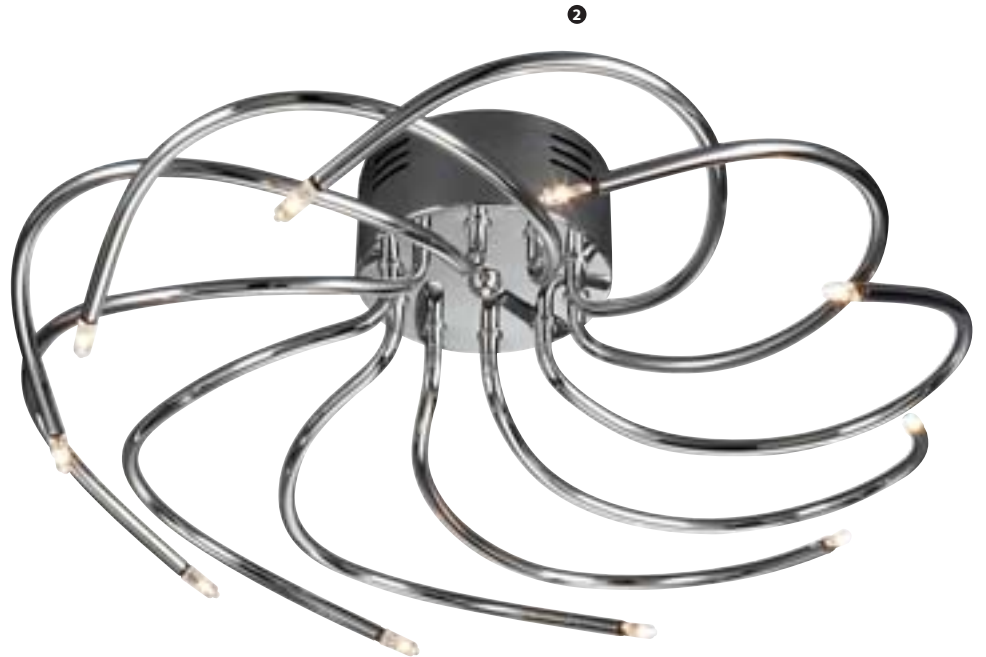

2



## Vito

**1 40530/11/13**

10x G4 | max. 20W |  $\frac{230}{12V}$  |  $\oplus$   
T 230 /  $\leftrightarrow$  625 /  $\nearrow$  570

**2 40531/11/13**

16x G4 | max. 20W |  $\frac{230}{12V}$  |  $\oplus$   
T 270 /  $\leftrightarrow$  785 /  $\nearrow$  760

## Velasco

**3 40532/11/13**

20x G4 | max. 10W |  $\frac{230}{12V}$  |  $\oplus$   
T 217 /  $\leftrightarrow$  580 /  $\nearrow$  580



1-3

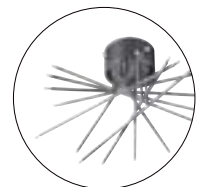
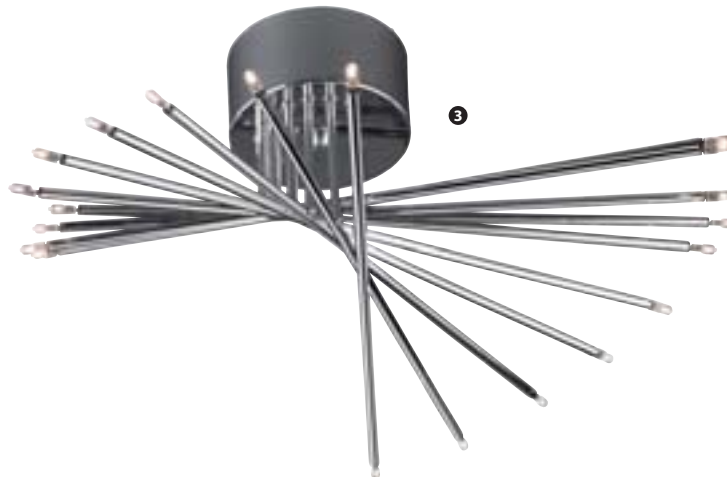
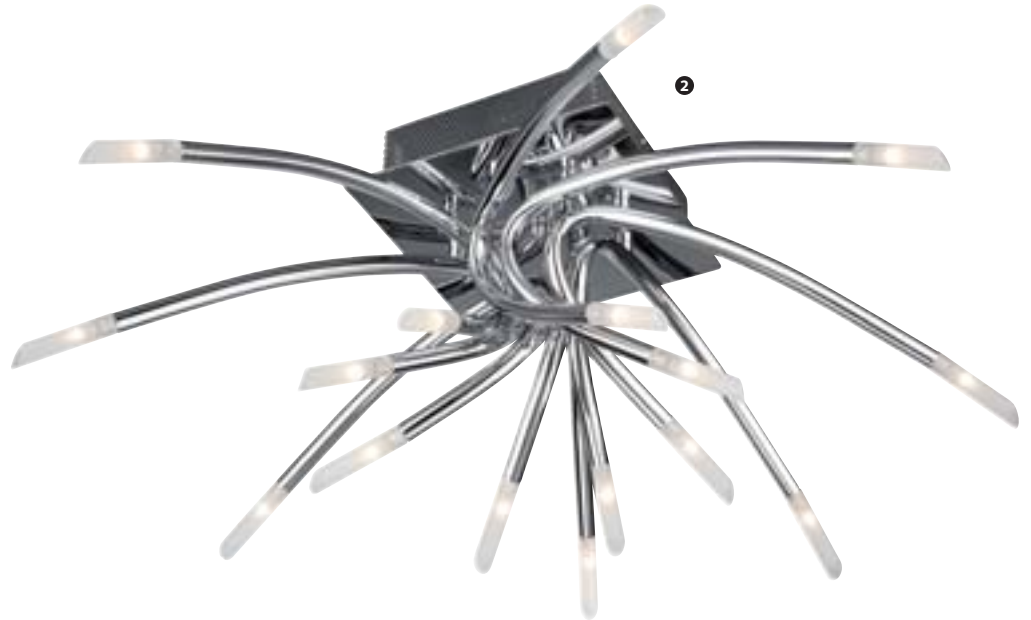
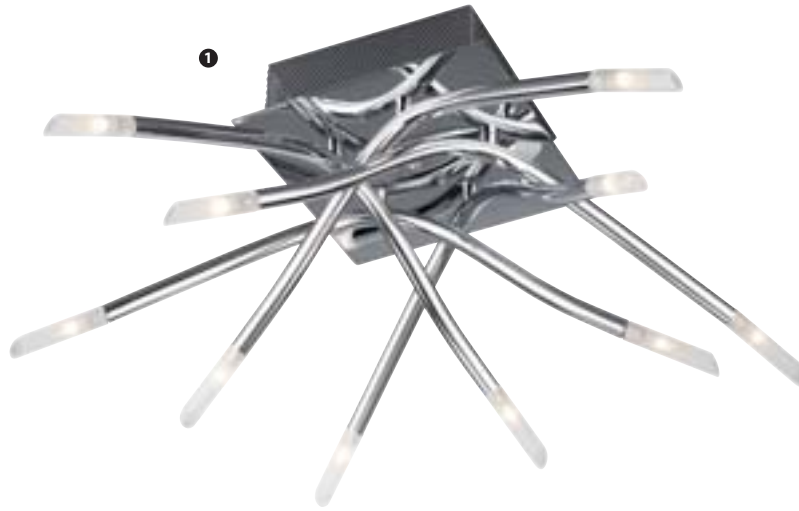

# Life

**1 40687/17/13**

21x G4 | max. 10W | 230V 12V | ⊕  
T 195 / ↔ 980 / ↗ 980

**2 40688/17/13**

10x G4 | max. 10W | 230V 12V | ⊕  
T 103 / ↔ 590 / ↗ 590

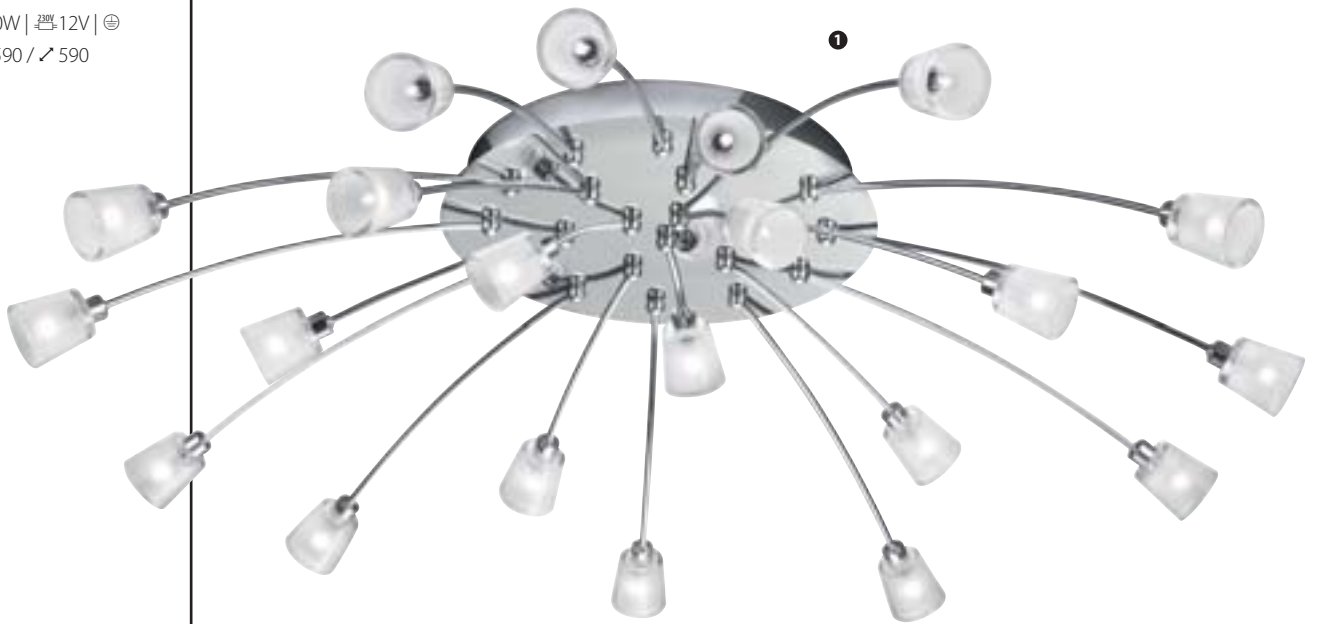

1→2

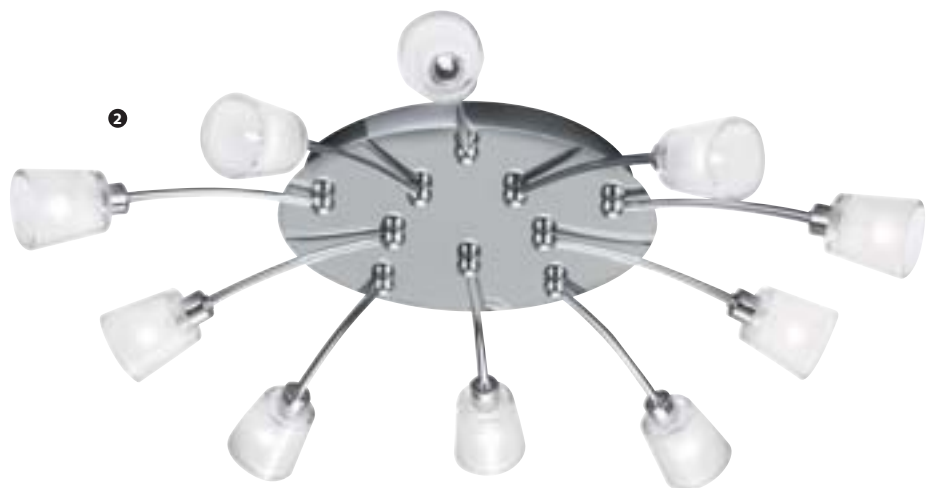



4



## Vardi

### 1 40650/11/13

6x G4 | max. 20W |  12V | 

4x G4 | max. 10W |  12V

T 170 / ↔ 325 / ↗ 325

### 2 40651/11/13

6x G4 | max. 20W |  12V | 

6x G4 | max. 10W |  12V

T 160 / ↔ 450 / ↗ 450

### 3 40652/11/13

5x G4 | max. 20W |  12V | 

4x G4 | max. 10W |  12V

T 170 / ↔ 320 / ↗ 320

### 4 40653/11/13

6x G4 | max. 20W |  12V | 

6x G4 | max. 10W |  12V

T 168 / ↔ 454 / ↗ 454



1→4



1



2



3







## Hayden

**1 30217/87/13**

4x 2G11 | max. 24W | 230V | ⊕  
T 80 / ↔ 505 / ↗ 505

**2 30218/87/13**

4x 2G11 | max. 40W | 230V | ⊕  
T 80 / ↔ 750 / ↗ 750

## Callisto

**3 30249/31/13**

9x G4 | max. 20W |  $\frac{230V}{12V}$  | ⊕  
T 170 / ↔ 400 / ↗ 400



1→2



3



1



2





# Kraft

❶ 40664/30/13

❷ 40664/33/13

❸ 40664/40/13

1x E27 | max. 60W | 230V | ⊕

↓ 1500 / ↔ 600 / ↗ 600

 Fit for energy saving lamps

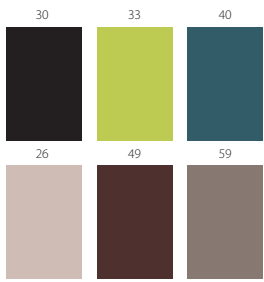

❷

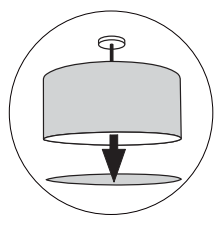

❸

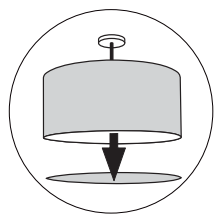



3

# Kraft

❶ 40664/26/13

❷ 40664/49/13

❸ 40664/59/13

1x E27 | max. 60W | 230V | ⊕

↓ 1500 / ↔ 600 / ↗ 600

 Fit for energy saving lamps

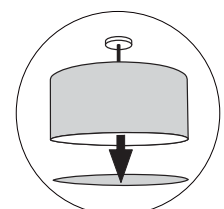
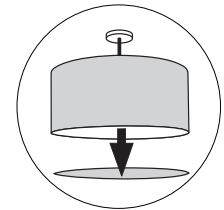
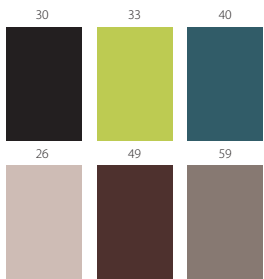

## Brevi

### ❶ 37966/30/13

1x E27 | max. 60W | 230V | ☐  
↓ 1385 / ↔ 400 / ↗ 580

### ❷ 37968/30/13

1x E27 | max. 60W | 230V | ☐  
↓ 1740 / ↔ 400 / ↗ 400

### ❸ 37969/30/13

1x E27 | max. 60W | 230V | ☐  
↓ 1110 / ↔ 400 / ↗ 400

 Fit for energy saving lamps



2→3



# Allegri

❶ 42159/30/13

❷ 42159/31/13

1x E27 | max. 60W | 230V | ☐

↓ 1520 / ↔ 340 / ↗ 340

❸ 43159/30/13

❹ 43159/31/13

1x E27 | max. 40W | 230V | ☐

↓ 495 / ↔ 205 / ↗ 205

 Fit for energy saving lamps



1→4

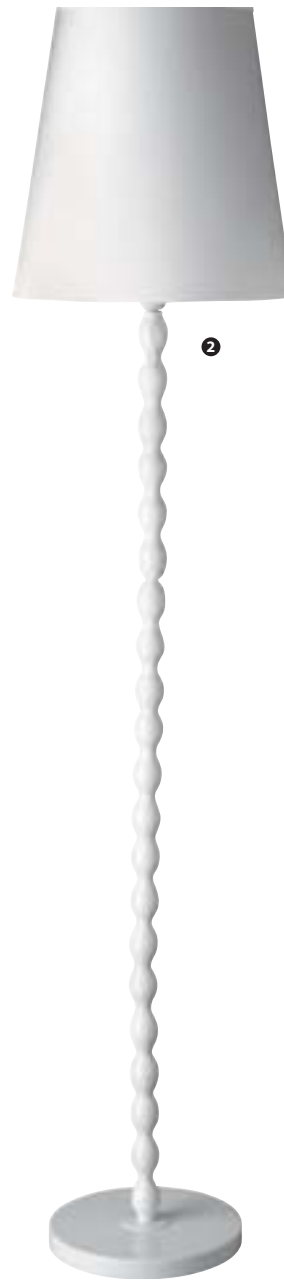

# Denza

❶ 42243/30/13

❷ 42243/31/13

2x E14 | max. 40W | 230V | ☐

↓ 1740 / ↔ 330 / ↗ 330

 Fit for energy saving lamps



1→2





## Kyran

**1 36251/30/13**

1x E27 | max. 60W | 230V | ⊕  
↓ 1400 / ↔ 512 / ↗ 512

**2 36253/30/13**

1x E27 | max. 60W | 230V | ⊞  
↓ 1630 / ↔ 560 / ↗ 760

 Fit for energy saving lamps



2

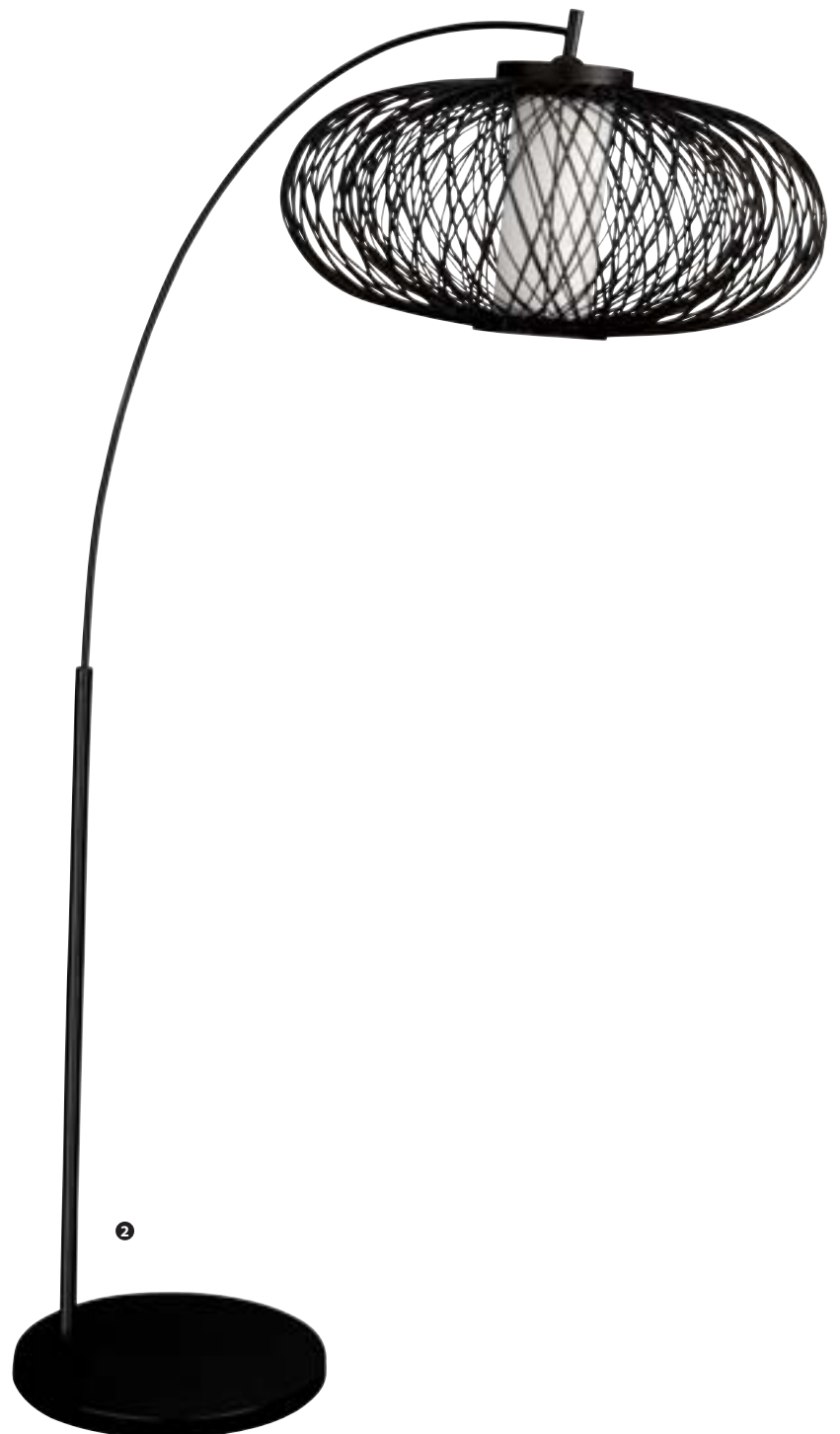



2

# Violla

**1 42147/43/13**

1x E27 | max. 60W | 230V | ☐  
↓ 1460 / ↔ 300 / ↗ 300

**2 43146/43/13**

1x E27 | max. 40W | 230V | ☐  
↓ 570 / ↔ 235 / ↗ 235

**3 45559/43/13**

1x E27 | max. 60W | 230V | ⊕  
↓ 332 / ↔ 150 / ↗ 275

 Fit for energy saving lamps



1→3





1

# Ramos

**1 37895/43/13**

6x E14 | max. 40W | 230V | ⊕  
↓ 1500 / ↔ 890 / ↗ 280

**2 37896/43/13**

4x E14 | max. 40W | 230V | ⊕  
↓ 280 / ↔ 600 / ↗ 220

**3 37897/43/13**

2x E14 | max. 60W | 230V | ⊕  
↓ 188 / ↔ 285 / ↗ 155

**4 37898/43/13**

4x E14 | max. 40W | 230V | ⊞  
↓ 1560 / ↔ 500 / ↗ 355

**5 37899/43/13**

3x E14 | max. 40W | 230V | ⊞  
↓ 447 / ↔ 300 / ↗ 210

 Fit for energy saving lamps



4→5

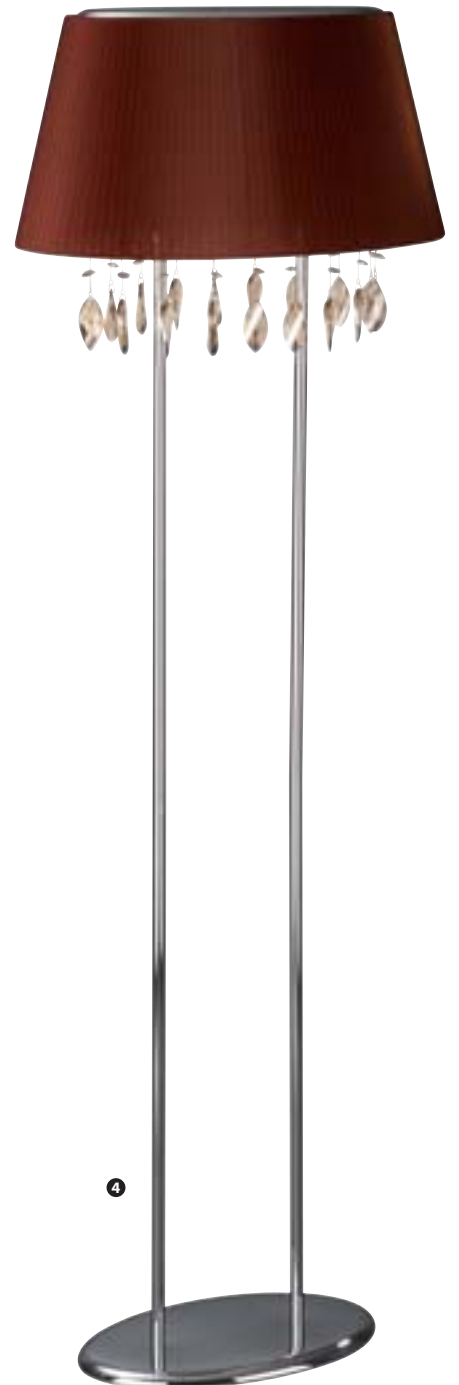



## Musto

**1 37840/86/13**

9x G4 | max. 20W |  12V | ⊕  
↓ 1200 / ↔ 760 / ↗ 760

**2 37841/86/13**

6x G4 | max. 20W |  12V | ⊕  
T 110 / ↔ 860 / ↗ 630

**3 37842/86/13**

2x G4 | max. 20W |  12V | ⊕  
↓ 1410 / ↔ 305 / ↗ 160

**4 37844/86/13**

2x G4 | max. 20W |  12V | ⊕  
↓ 1450 / ↔ 170 / ↗ 170



4



1→4

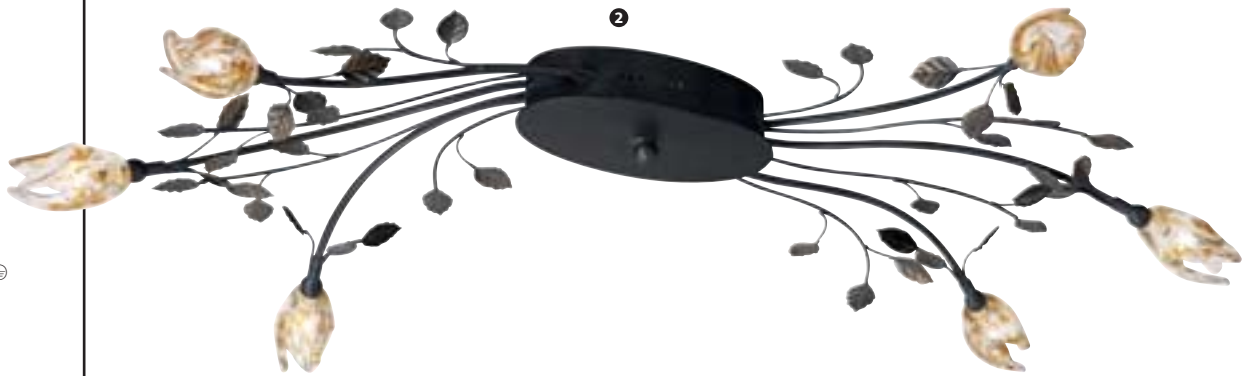

## Corelli

**❶ 37455/18/13**

8x E14 | max. 40W | 230V | ⊕

↓ 1350 / ↔ 690 / ↗ 690

**❷ 37457/18/13**

2x E14 | max. 40W | 230V | ⊕

↓ 280 / ↔ 280 / ↗ 200





## Corelli

**1 37456/18/13**

5x E14 | max. 40W | 230V | ⊕  
↓ 1160 / ↔ 600 / ↗ 600

**2 37458/18/13**

3x E14 | max. 40W | 230V | ⊕  
T 300 / ↔ 410 / ↗ 410





## Corelli

**1 37455/86/13**

8x E14 | max. 40W | 230V | ⊕  
↓ 1350 / ↔ 690 / ↗ 690

**2 37456/86/13**

5x E14 | max. 40W | 230V | ⊕  
↓ 1160 / ↔ 600 / ↗ 600

**3 37457/86/13**

2x E14 | max. 40W | 230V | ⊕  
↓ 280 / ↔ 280 / ↗ 200

**4 37458/86/13**

3x E14 | max. 40W | 230V | ⊕  
↓ 300 / ↔ 410 / ↗ 410



## Molino

**1 37436/29/13**

1x E27 | max. 60W | 230V | ⊕

↓ 1000 / ↔ 370 / ↗ 370

**2 37437/29/13**

1x E14 | max. 40W | 230V | ⊕

↓ 200 / ↔ 240 / ↗ 135

 Fit for energy saving lamps



## Molino

**1 37436/86/13**

1x E27 | max. 60W | 230V | ⊕

↓ 1000 / ↔ 370 / ↗ 370

**2 37437/86/13**

1x E14 | max. 40W | 230V | ⊕

↓ 200 / ↔ 240 / ↗ 135

 Fit for energy saving lamps





## Vivaldi

### ❶ 40364/30/13

6x E14 | max. 40W | 230V | ⊕  
↓ 1230 / ↔ 740 / ↗ 740

### ❷ 40381/30/13

6x E14 | max. 40W | 230V | ⊕  
↓ 275 / ↔ 900 / ↗ 630

### ❸ 45552/30/13

2x E14 | max. 40W | 230V | ⊕  
↓ 390 / ↔ 355 / ↗ 240

 Fit for energy saving lamps



## Rameau

### ❶ 37271/92/13

5x E14 | max. 40W | 230V | ⊕  
↓ 1270 / ↔ 810 / ↗ 810

### ❷ 37275/92/13

2x E27 | max. 60W | 230V | ⊕  
↓ 1210 / ↔ 890 / ↗ 315

### ❸ 37276/92/13

1x E27 | max. 60W | 230V | ⊕  
↓ 1160 / ↔ 395 / ↗ 395

 Fit for energy saving lamps





## Rameau

**1 37272/92/13**

1x E14 | max. 60W | 230V | ⊕  
↓ 270 / ↔ 310 / ↗ 157

**2 37273/92/13**

1x E27 | max. 60W | 230V | ⊞  
↓ 1825 / ↔ 400 / ↗ 400

**3 37274/92/13**

1x E27 | max. 60W | 230V | ⊞  
↓ 480 / ↔ 320 / ↗ 320

 Fit for energy saving lamps



2→3



## Rameau

**1 30263/43/13**

2x E14 | max. 60W | 230V | ☐  
T 70 / ↔ 300 / ↗ 300

**2 30264/43/13**

3x E27 | max. 60W | 230V | ☐  
T 120 / ↔ 440 / ↗ 440

**3 33263/43/13**

1x E14 | max. 60W | 230V | ⊕  
I 100 / ↔ 260 / ↗ 160

**4 33264/43/13**

1x E27 | max. 60W | 230V | ⊕  
I 270 / ↔ 160 / ↗ 135

 Fit for energy saving lamps



## Elvey

**1 40641/43/13**

2x E27 | max. 40W | 230V | ☐

T 100 / ↔ 465 / ↗ 410

**2 40642/43/13**

3x E27 | max. 40W | 230V | ☐

T 160 / ↔ 600 / ↗ 520

 Fit for energy saving lamps



## Camillo

**1 38005/43/13**

4x E27 | max. 60W | 230V | ⊕  
↓ 1140 / ↔ 890 / ↗ 135

**2 38006/43/13**

5x E27 | max. 60W | 230V | ⊕  
↓ 1100 / ↔ 615 / ↗ 615

**3 38009/43/13**

1x E27 | max. 60W | 230V | ⊕  
↓ 445 / ↔ 150 / ↗ 230

 Fit for energy saving lamps



3



## Camillo

**1 38007/43/13**

1x E27 | max. 60W | 230V | ⊕  
↓ 175 / ↔ 135 / ↗ 190

**2 38008/43/13**

2x E27 | max. 60W | 230V | ⊕  
↓ 1670 / ↔ 443 / ↗ 300

**3 38010/43/13**

4x E27 | max. 60W | 230V | ⊕  
T 230 / ↔ 585 / ↗ 415

 Fit for energy saving lamps



2



## Torelli

### ❶ 38000/43/13

9x G4 | max. 20W | 12V | ⊕  
↓ 1100 / ↔ 630 / ↗ 550

### ❷ 38001/43/13

6x G4 | max. 20W | 12V | ⊕  
T 300 / ↔ 700 / ↗ 390



1→2



## Torelli

### 1 38002/43/13

2x G4 | max. 20W | 12V | ⊕  
1 435 / ↔ 250 / ↗ 185

### 2 38003/43/13

6x G4 | max. 20W | 12V | ⊕  
1 1640 / ↔ 430 / ↗ 300

### 3 38004/43/13

2x G4 | max. 20W | 12V | ⊕  
1 425 / ↔ 225 / ↗ 185



1→3



2→3

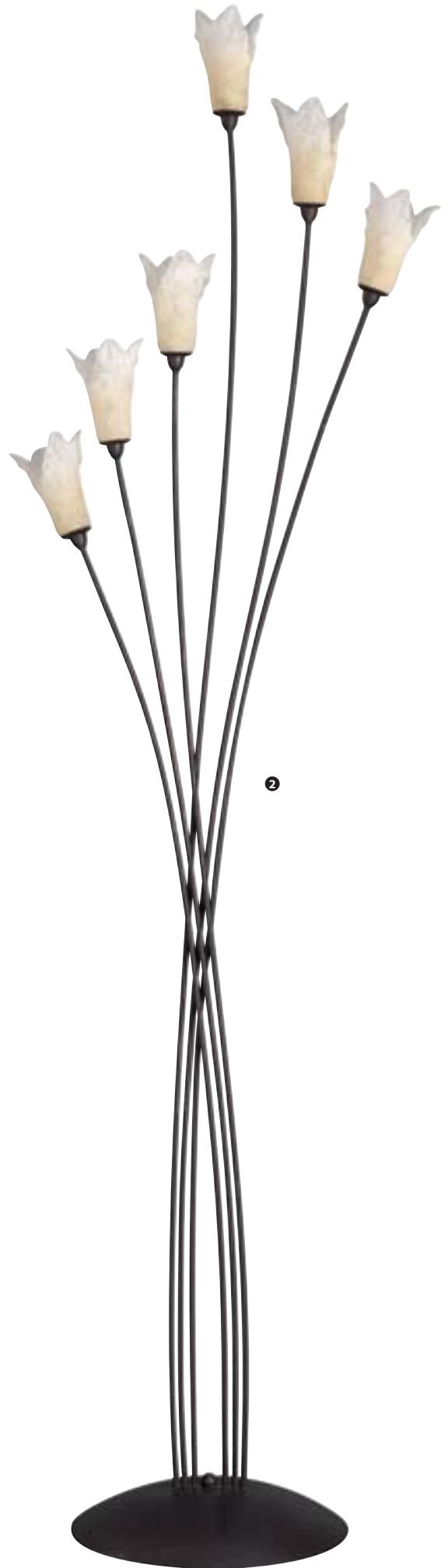



1



## Lyris

**1 37290/86/13**

6x G9 | max. 42W | 230V | ☉

☑ 28W incl.

↓ 1280 / ↔ 650 / ↗ 650

**2 37291/86/13**

6x G9 | max. 42W | 230V | ☉

☑ 28W incl.

T 365 / ↔ 660 / ↗ 660

**3 37292/86/13**

2x G9 | max. 42W | 230V | ☉

☑ 28W incl.

↓ 530 / ↔ 325 / ↗ 200

**4 37294/86/13**

2x G9 | max. 42W | 230V | ☐

☑ 28W incl.

↓ 470 / ↔ 163 / ↗ 356



4



1→4



## Foster

**1 37485/86/13**

2x E27 | max. 60W | 230V | ⊕  
↓ 1500 / ↔ 1080 / ↗ 320

**2 37487/86/13**

1x E27 | max. 60W | 230V | ⊕  
↓ 230 / ↔ 240 / ↗ 320

 Fit for energy saving lamps

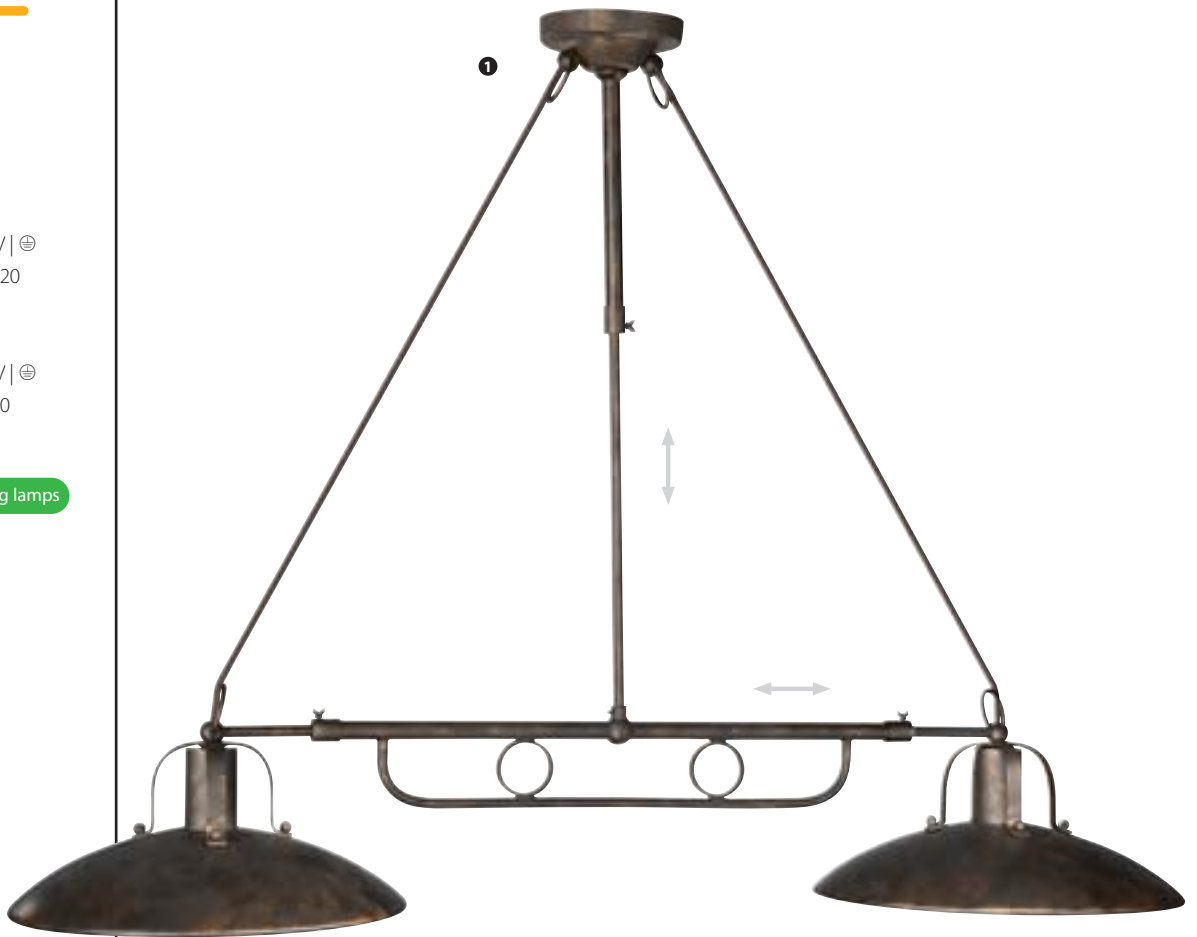

## Foster

❶ 37486/86/13

1x E27 | max. 60W | 230V | ⊕

↓ 1500 / ↔ 320 / ↗ 320

## Torres

❷ 40382/43/13

1x E27 | max. 40W | 230V | ⊕

↓ 1100 / ↔ 300 / ↗ 300

 Fit for energy saving lamps

## Jacobi

❸ 40639/43/13

3x E14 | max. 40W | 230V | ⊕

↓ 1140 / ↔ 300 / ↗ 300



## Susato

### ❶ 42206/17/13

1x E27 | max. 12W | 230V | ☐

💡 12W incl.

↑ 1525 / ↔ 300 / ↗ 300

### ❷ 45551/17/13

1x E27 | max. 12W | 230V | ⊕

💡 12W incl.

↑ 200 / ↔ 125 / ↗ 210



1



2



1→2

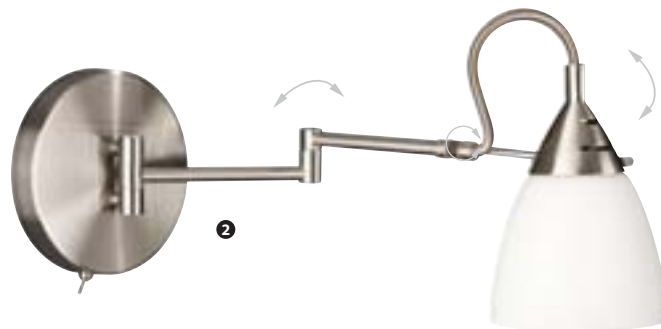

## Singer

**❶ 67011/17/13**

1x GY 6,35 | max. 50W | 230V 12V | □  
↑ 520 / ↔ 200 / ↗ 740

**❷ 67751/17/13**

1x GY 6,35 | max. 50W | 230V 12V | □  
↑ 1500 / ↔ 250 / ↗ 830



1



2



1→2



# Catalina

**1 40331/17/13**

1x GR10 | max. 55W | 230V | ⊕  
↓ 1500 / ↔ 500 / ↗ 500

**2 42179/11/13**

1x GR10 | max. 55W | 230V | ⊕  
↓ 1800 / ↔ 400 / ↗ 400



2



1→2

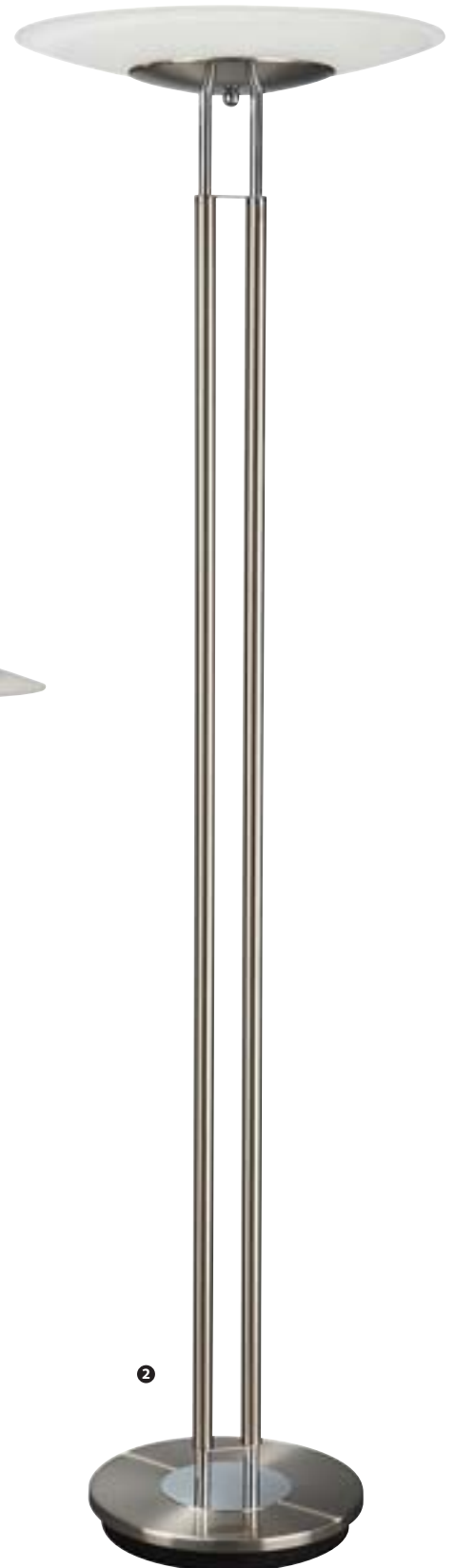

# Marcello

❶ 37433/13/13

❷ 37433/17/13

1x R7S | max. 300W | 230V | ⚡

💡 200W incl.

1x G9 | max. 42W | 230V

💡 28W incl.

↑ 1840 / ↔ 380 / ↗ 380

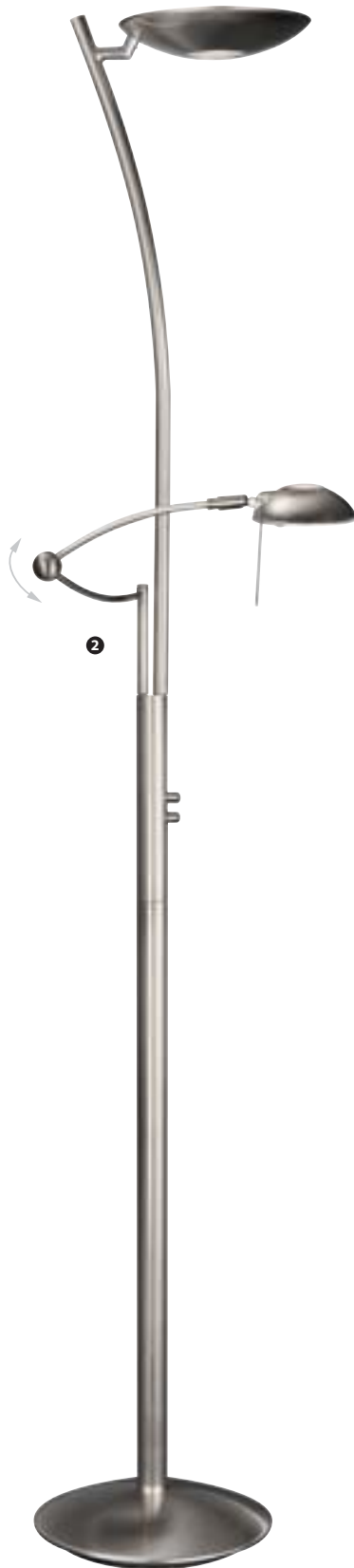

# Mucha

❶ 40307/31/13

❷ 40307/55/13

1x E27 | max. 60W | 230V | Ⓢ

↓ 1190 / ↔ 400 / ↗ 400

 Fit for energy saving lamps





# Mucha

❶ 42307/31/13

❷ 42307/55/13

1x E27 | max. 75W | 230V | ☐

↓ 2090 / ↔ 400 / ↗ 1750

 Fit for energy saving lamps





1

## Marti

❶ 42216/11/13

❷ 42216/17/13

1x E27 | max. 23W | 230V | ☐

💡 23W incl.

↓ 1617 / ↔ 350 / ↗ 930

## Gisli

❸ 42217/17/13

1x E27 | max. 100W | 230V | ☐

↓ 1920 / ↔ 500 / ↗ 1850

💡 Fit for energy saving lamps



1→2



3



1→2



# Lauro

❶ 42226/06/13

❷ 42226/17/13

❸ 42226/43/13

1x E27 | max. 23W | 230V | 

 23W incl.

1x GX53 | max. 9W | 230V

 9W incl.

↓ 1720 / ↔ 500 / ↗ 500



# Lorca

❶ 42227/06/13

❷ 42227/17/13

1x E27 | max. 23W | 230V | 

 23W incl.

1x GX53 | max. 9W | 230V

 9W incl.

↓ 1700 / ↔ 380 / ↗ 180



1→2



1→2



1→2



1→2



# Vidal

❶ 42233/06/13

❷ 42233/17/13

❸ 42233/30/13

1x T5 | max. 55W | 230V | ☐

⌚ 55W incl.

1x PowerLED | max. 2,5W | SELV

↓ 1829 / ↔ 395 / ↗ 395



1→3



1→3



1→3



1→3



## Tallis

❶ 42225/17/13

1x E27 | max. 23W | 230V | ☐

☞ 23W incl.

1x G9 | max. 40W | 230V

↓ 1700 / ↔ 320 / ↗ 320

## Eran

❷ 42228/17/13

1x E27 | max. 23W | 230V | ☐

☞ 23W incl.

1x E14 | max. 9W | 230V

☞ 8W incl.

↓ 1700 / ↔ 385 / ↗ 280



1



1



2



1



1



2



2



## Bellini

❶ 43144/30/13

1x E27 | max. 60W | 230V | ☐

1 575 / ↔ 360 / ↗ 225

## Boyce

❷ 43149/43/13

❸ 43149/75/13

1x E14 | max. 40W | 230V | ☐

1 345 / ↔ 300 / ↗ 165

## Ilio

❹ 43158/43/13

❺ 43158/75/13

1x E14 | max. 60W | 230V | ☐

1 450 / ↔ 285 / ↗ 285

 Fit for energy saving lamps



1→5





## Zinnias

❶ 43232/06/13

❷ 43232/11/13

❸ 43232/17/13

1x E14 | max. 40W | 230V | ☐  
↑ 168 / ↔ 100 / ↗ 100

❹ 43233/06/13

❺ 43233/11/13

❻ 43233/17/13

1x E14 | max. 40W | 230V | ☐  
↑ 185 / ↔ 125 / ↗ 125



1→6



## Nano

**1 55420/11/13**

1x GU10 | max. 50W | 230V | ⊕  
↑ 100 / ↔ 100 / ↗ 104

**2 55424/11/13**

4x GU10 | max. 50W | 230V | ⊕  
↑ 105 / ↔ 260 / ↗ 260



1



1→2



## Nano

**1 55422/11/13**

2x GU10 | max. 50W | 230V | ⊕  
T 104 / ↔ 263 / ↗ 110

**2 55423/11/13**

3x GU10 | max. 50W | 230V | ⊕  
T 105 / ↔ 402 / ↗ 110



1→2



1



2





4

## Versus

### ❶ 55930/17/13

1x E14 | max. 9W | 230V | Ⓢ

💡 9W incl.

⊥ 150 / ↔ 80 / ↗ 122

### ❷ 55932/17/13

2x E14 | max. 9W | 230V | Ⓢ

💡 9W incl.

⊥ 80 / ↔ 400 / ↗ 122

### ❸ 55933/17/13

3x E14 | max. 9W | 230V | Ⓢ

💡 9W incl.

⊥ 122 / ↔ 240 / ↗ 240

### ❹ 55934/17/13

4x E14 | max. 9W | 230V | Ⓢ

💡 9W incl.

⊥ 135 / ↔ 790 / ↗ 110

### ❺ 55936/17/13

6x E14 | max. 9W | 230V | Ⓢ

💡 9W incl.

⊥ 160 / ↔ 1800 / ↗ 105



1



1→5



## Minho

**1 55550/31/13**

1x GU10 | max. 50W | 230V | Ⓢ

↑ 82 / ↔ 100 / ↘ 84

**2 55552/31/13**

2x GU10 | max. 50W | 230V | Ⓢ

↑ 82 / ↔ 195 / ↘ 80

**3 55553/31/13**

3x GU10 | max. 50W | 230V | Ⓢ

↑ 82 / ↔ 305 / ↘ 80

**4 55554/31/13**

4x GU10 | max. 50W | 230V | Ⓢ

↑ 82 / ↔ 195 / ↘ 195



1→4



1



2



4



3



## Minho

**1 55550/48/13**

1x GU10 | max. 50W | 230V | ⊕  
↑ 82 / ↔ 100 / ↘ 84

**2 55552/48/13**

2x GU10 | max. 50W | 230V | ⊕  
↑ 82 / ↔ 195 / ↘ 80

**3 55553/48/13**

3x GU10 | max. 50W | 230V | ⊕  
↑ 82 / ↔ 305 / ↘ 80

**4 55554/48/13**

4x GU10 | max. 50W | 230V | ⊕  
↑ 82 / ↔ 195 / ↘ 195



1→4



Article Pg. Sparepart EAN-number article

























30217/87/13	63	☐ 30217/31/0P	5	 413987 047510
30218/87/13	63	☐ 30218/31/0P	5	 413987 047527
30249/31/13	63		5	 413987 060748
30263/43/13	88	Ⓢ GN064/00/31	5	 413987 072734
30264/43/13	88	Ⓢ GN063/90/31	5	 413987 072741
33263/43/13	88	Ⓢ GF046/50/31	5	 413987 072758
33264/43/13	88	Ⓢ GF046/60/31	5	 413987 072765
36251/30/13	71	Ⓢ 36251/31/0G	5	 413987 071591
36253/30/13	71	Ⓢ 36253/31/0G	5	 413987 072000
37030/17/13	25	Ⓢ GN049/40/69	5	 413987 006760
37031/17/13	25	Ⓢ GN049/40/69	5	 413987 006791
37032/17/13	24	Ⓢ GN049/40/69	5	 413987 006807
37033/17/13	25	Ⓢ GN049/40/69	5	 413987 006777
37034/17/13	24	Ⓢ GN049/40/69	5	 413987 006784
37036/17/13	24	Ⓢ GN049/40/69	5	 413987 006814
		Ⓢ GR007/50/69		
37060/11/13	55	Ⓢ HA077/30/60	5	 413987 006944
37061/11/13	55	Ⓢ HA077/30/60	5	 413987 006951
37064/11/13	57	Ⓢ 37064/31/0G	5	 413987 073298
37065/11/13	57		5	 413987 006982
37070/17/13	23	Ⓢ GN049/60/56	5	 413987 007019
37071/17/13	23	Ⓢ GN049/60/56	5	 413987 007026
37271/92/13	86	Ⓢ GN064/11/43	5	 413987 072772
37272/92/13	87	Ⓢ GF046/70/31	5	 413987 072819
37273/92/13	87	Ⓢ 37276/31/0G	5	 413987 072826

Article Pg. Sparepart EAN-number article

37274/92/13	87	Ⓢ 37274/31/0G	5	 413987 072802
37275/92/13	86	Ⓢ 37275/31/0G	5	 413987 072789
37276/92/13	86	Ⓢ 37276/31/0G	5	 413987 072796
37290/86/13	95	Ⓢ GF042/55/62	5	 413987 019753
37291/86/13	95	Ⓢ GF042/55/62	5	 413987 019760
37292/86/13	95	Ⓢ GF042/55/62	5	 413987 019869
37294/86/13	95	Ⓢ GF042/55/62	5	 413987 019876
37425/11/13	38	Ⓢ GE001/20/60	5	 413987 043086
		Ⓢ HA093/50/11		
37426/11/13	42	Ⓢ HA096/70/60	5	 413987 043109
37427/11/13	38	Ⓢ GE001/20/60	5	 413987 044731
		Ⓢ HA093/50/11		
37428/11/13	39	Ⓢ GE001/20/60	5	 413987 043093
		Ⓢ HA093/50/11		
37429/11/13	39	Ⓢ GE001/20/60	5	 413987 043079
		Ⓢ HA093/50/11		
37433/13/13	101	Ⓢ GB008/30/60	5	 413987 042966
		Ⓢ GR004/70/60		
		Ⓢ GR008/90/67		
37433/17/13	101	Ⓢ GB008/30/60	5	 413987 042973
		Ⓢ GR004/70/60		
		Ⓢ GR008/90/67		
37436/29/13	82		5	 413987 042898
37436/86/13	83		5	 413987 042904
37437/29/13	82		5	 413987 042911



Article Pg. Sparepart EAN-number article

37437/86/13	83		5	
37445/11/13	45	Ⓢ GF044/10/60	5	
37448/11/13	45	Ⓢ GF044/10/60	5	
37455/18/13	78	Ⓢ HA093/60/60	5	
37455/86/13	81	Ⓢ HA093/60/60	5	
37456/18/13	79	Ⓢ HA093/60/60	5	
37456/86/13	81	Ⓢ HA093/60/60	5	
37457/18/13	78	Ⓢ HA093/60/60	5	
37457/86/13	81	Ⓢ HA093/60/60	5	
37458/18/13	79	Ⓢ HA093/60/60	5	
37458/86/13	81	Ⓢ HA093/60/60	5	
37485/86/13	96		5	
37486/86/13	97		5	
37487/86/13	96		5	
37570/60/13	37	Ⓢ GF043/90/69	5	
37571/60/13	37	Ⓢ GF043/90/69	5	
37573/60/13	37	Ⓢ GF043/90/69	5	
37586/11/13	16	Ⓢ 37586/31/0G	5	
37588/11/13	16	Ⓢ 37589/31/0G	5	
37589/11/13	16	Ⓢ 37589/31/0G	5	
37595/17/13	9	Ⓢ HA101/70/00	5	
37596/17/13	9	Ⓢ HA101/70/00	5	
37597/17/13	9	Ⓢ HA101/70/00	5	
37598/17/13	9	Ⓢ HA101/70/00	5	
37599/17/13	9	Ⓢ HA101/70/00	5	

Article Pg. Sparepart EAN-number article

37811/17/13	13	Ⓢ 37811/31/0G	5	
37812/17/13	13	Ⓢ 37812/31/0G	5	
37814/17/13	13	Ⓢ 37814/31/0G	5	
37815/11/13	41	Ⓢ 37815/60/0G	5	
		Ⓢ 37815/60/1G		
37816/11/13	41	Ⓢ 37815/60/1G	5	
		Ⓢ 37816/60/0G		
37818/11/13	41	Ⓢ 37815/60/1G	5	
		Ⓢ 37816/60/0G		
37820/11/13	49	Ⓢ 37820/60/0G	5	
37821/17/13	49	Ⓢ 37821/60/0G	5	
37840/86/13	77	Ⓢ 37840/34/0G	5	
37841/86/13	77	Ⓢ 37840/34/0G	5	
37842/86/13	77	Ⓢ 37840/34/0G	5	
37844/86/13	77	Ⓢ 37840/34/0G	5	
37845/17/13	27	Ⓢ 37846/31/0G	5	
37845/43/13	29	Ⓢ 37846/84/0G	5	
37846/17/13	26	Ⓢ 37846/31/0G	5	
37846/43/13	29	Ⓢ 37846/84/0G	5	
37847/17/13	27	Ⓢ 37846/31/0G	5	
37847/43/13	29	Ⓢ 37846/84/0G	5	
37848/17/13	26	Ⓢ 37846/31/0G	5	
37848/43/13	29	Ⓢ 37846/84/0G	5	
37849/17/13	27	Ⓢ 37846/31/0G	5	
37849/43/13	29	Ⓢ 37846/84/0G	5	

Article Pg. Sparepart EAN-number article

37895/43/13 75 ① 37895/43/0G 5  413987 081682

△ 37895/43/0S

37896/43/13 75 ① 37895/43/0G 5  413987 081699

△ 37896/43/0S

37897/43/13 75 ① 37895/43/0G 5  413987 081729

△ 37897/43/0S

37898/43/13 75 ① 37895/43/0G 5  413987 081705

△ 37898/43/0S

37899/43/13 75 ① 37895/43/0G 5  413987 081712

△ 37899/43/0S

37966/30/13 68 △ 37966/30/0S 5  413987 126727

37968/30/13 68 △ 37966/30/0S 5  413987 114571

37969/30/13 68 △ 37969/30/0S 5  413987 114588

37985/11/13 56 5  413987 114595

37986/11/13 56 5  413987 123290

37987/11/13 56 5  413987 122774

38000/43/13 92 ① 38001/31/0G 5  413987 099373

38001/43/13 92 ① 38001/31/0G 5  413987 099366

38002/43/13 93 ① 38001/31/0G 5  413987 099380

38003/43/13 93 ① 38001/31/0G 5  413987 099403

38004/43/13 93 ① 38001/31/0G 5  413987 099397

38005/43/13 90 ① 38005/31/0G 5  413987 099496

38006/43/13 90 ① 38005/31/0G 5  413987 103568

38007/43/13 91 ① 38005/31/0G 5  413987 099502

38008/43/13 91 ① 38005/31/0G 5  413987 099601

Article Pg. Sparepart EAN-number article

38009/43/13 90 ① 38005/31/0G 5  413987 099519

38010/43/13 91 ① 38005/31/0G 5  413987 099595

40307/31/13 102 ① 40307/31/0P 5  413987 007071

40307/55/13 102 ① 40307/55/0P 5  413987 007088

40331/17/13 100 ① GR010/20/67 5  413987 039867

① GS011/00/67

40364/30/13 85 ① 40364/30/0G 5  413987 048371

40381/30/13 85 ① 40364/30/0G 5  413987 048364

40382/43/13 97 ① GN061/30/67 5  413987 048326

40385/60/13 54 ① HA096/80/67 5  413987 048470

① HA097/00/60

① HA097/10/60

40386/60/13 54 ① HA096/80/67 5  413987 048487

① HA097/00/60

① HA097/10/60

40394/11/13 40 5  413987 048722

40431/17/13 40 ① 40431/60/0G 5  413987 050428

40439/11/13 42 5  413987 060687

40523/17/13 17 ① 40523/31/0G 5  413987 070716

① 40523/60/0G

40524/17/13 17 ① 40523/31/0G 5  413987 070723













① 40523/60/0G

40525/11/13 36 ① 40525/60/0G 5  413987 072871













40526/11/13 36 ① 40525/60/0G 5  413987 072888

40527/11/13 47 ① 40527/11/0G 5  413987 071645

Article Pg. Sparepart EAN-number article

40527/11/13	47	④ 40527/11/1G	
40528/11/13	47	④ 40527/11/0G	5  413987 075575
		④ 40527/11/1G	
40529/11/13	47	④ 40527/11/0G	5  413987 071652
		④ 40527/11/1G	
40530/11/13	58	④ 40530/31/0G	5  413987 072581
40531/11/13	58	④ 40530/31/0G	5  413987 072598
40532/11/13	58		5  413987 071348
40533/11/13	45	④ HA099/80/55	5  413987 072857
		④ HA099/90/67	
40534/11/13	45	④ HA099/90/67	5  413987 072864
40639/43/13	97	④ 40639/43/0G	5  413987 099526
40641/43/13	89	④ 40641/31/0G	5  413987 099342
40642/43/13	89	④ 40642/31/0G	5  413987 099458
40644/06/13	21		5  413987 103506
40644/17/13	19	④ 40644/31/0G	5  413987 099533
40645/06/13	21		5  413987 103513
40645/17/13	19	④ 40644/31/0G	5  413987 099540
40646/06/13	21		5  413987 103537
40646/17/13	19	④ 40644/31/0G	5  413987 099588
40647/11/13	31	④ 40647/60/0G	5  413987 099557
40647/86/13	33	④ 40647/60/1G	5  413987 099564
40648/11/13	31	④ 40647/60/0G	5  413987 103544
40648/86/13	33	④ 40647/60/1G	5  413987 103551
40649/11/13	31	④ 40647/60/0G	5  413987 099571

Article Pg. Sparepart EAN-number article

40649/86/13	33	④ 40647/60/1G	5  413987 103520
40650/11/13	61	④ 40650/60/0G	5  413987 099434
40651/11/13	61	④ 40651/60/0G	5  413987 099472
40652/11/13	61	④ 40652/60/0G	5  413987 099441
		④ 40652/60/1G	
40653/11/13	61	④ 40653/60/0G	5  413987 099489
		④ 40653/60/1G	
40663/17/13	23	④ GN049/60/56	5  413987 109089
40664/26/13	65	④ 40664/31/0X	5  413987 118197
		△ 40664/87/0S	
40664/30/13	65	△ 40664/30/0S	5  413987 118203
		④ 40664/31/0X	
40664/33/13	65	④ 40664/31/0X	5  413987 118210
		△ 40664/33/0S	
40664/40/13	65	④ 40664/31/0X	5  413987 118227
		△ 40664/40/0S	
40664/49/13	67	④ 40664/31/0X	5  413987 118234
		△ 40664/49/0S	
40664/59/13	67	④ 40664/31/0X	5  413987 118265
		△ 40664/31/1X	
40665/11/13	34	④ 40666/31/0G	5  413987 119637
40666/11/13	34	④ 40666/31/0G	5  413987 119620
40667/11/13	48	④ 40667/11/0G	5  413987 114441
40668/11/13	48	④ 40667/11/0G	5  413987 114458
40669/11/13	48	④ 40667/11/0G	5  413987 114489

Article Pg. Sparepart EAN-number article

40671/17/13 10 ④ 40671/31/0G 5  413987 114625

40671/43/13 11 ④ 40671/31/0G 5  413987 122767

40672/17/13 10 ④ 40671/31/0G 5  413987 122798

40672/43/13 11 ④ 40671/31/0G 5  413987 122804

40673/17/13 10 ④ 40671/31/0G 5  413987 114465

40673/43/13 11 ④ 40671/31/0G 5  413987 122743

40674/11/13 50 ④ 40674/11/0G 5  413987 126178

40675/11/13 50 ④ 40674/11/0G 5  413987 126185

40676/11/13 51 ④ 40674/11/0G 5  413987 126352

40677/11/13 51 ④ 40674/11/0G 5  413987 126345

40678/11/13 53 ④ 40678/60/0G 5  413987 114618

④ 40678/60/1G

40679/11/13 53 ④ 40679/60/0G 5  413987 115578

④ 40679/60/1G

④ 40679/60/2G

④ 40679/60/3G

40680/11/13 53 ④ 40680/60/0G 5  413987 119644

④ 40680/60/1G

④ 40680/60/2G

40681/11/13 42 △ 40681/48/0S 5  413987 115561

④ 40681/60/0G

40682/11/13 42 △ 40681/48/0S 5  413987 114601

④ 40681/60/0G

40683/43/13 35 ④ 40683/31/0G 5  413987 123283

40684/43/13 35 ④ 40683/31/0G 5  413987 123276

Article Pg. Sparepart EAN-number article

40685/11/13 14 ④ 40685/31/0G 5  413987 116209

40685/31/13 15 ④ 40685/31/0G 5  413987 126031

40687/17/13 59 ④ 40687/60/0G 5  413987 116216

40688/17/13 59 ④ 40687/60/0G 5  413987 116223

40722/11/13 14 ④ 43251/31/0G 5  413987 134166

40722/31/13 15 ④ 43251/31/0G 5  413987 134173

42147/43/13 73 △ 42147/31/0S 5  413987 050282

42159/30/13 69 △ 42159/30/0S 5  413987 071577

42159/31/13 69 △ 42159/31/0S 5  413987 074622

42179/11/13 100 ④ GR010/20/67 5  413987 035104

④ GS011/00/67

42206/17/13 98 ④ GN059/50/56 5  413987 048494

42216/11/13 105 △ 42216/30/0S 5  413987 071669

42216/17/13 105 △ 42216/31/0S 5  413987 071676

42217/17/13 105 △ 42217/30/0S 5  413987 071560

42225/17/13 109 ④ GN064/20/31 5  413987 071386

④ GN064/30/31

42226/06/13 106 △ 42226/38/0S 5  413987 071362

42226/17/13 106 △ 42226/31/0S 5  413987 071379

42226/43/13 106 △ 42226/38/0S 5  413987 071683

42227/06/13 107 △ 42227/38/0S 5  413987 071393





42227/17/13 107 △ 42227/31/0S 5  413987 071539

42228/17/13 109 ④ 42228/31/0G 5  413987 071355

④ 42228/31/1G

42233/06/13 108 ④ 42233/31/0G 5  413987 099311

Article Pg. Sparepart EAN-number article

42233/17/13	108	① 42233/31/0G	5	
42233/30/13	108	① 42233/31/0G	5	
42243/30/13	70		5	
42243/31/13	70		5	
42307/31/13	103	② 40307/31/0P	5	
42307/55/13	103	① GN050/80/56	5	
43144/30/13	110	△ 43144/30/0S	5	
43146/43/13	73	△ 43146/31/0S	5	
43149/43/13	110	△ 43149/34/0S	5	
43149/75/13	110	△ 43149/34/0S	5	
43158/43/13	110	△ 43158/43/0S	5	
43158/75/13	110	△ 43158/31/0S	5	
43159/30/13	69	△ 43159/30/0S	5	
43159/31/13	69	△ 43159/31/0S	5	
43231/30/13	7		5	
43231/31/13	7		5	
43231/32/13	7		5	
43232/06/13	111	① 43232/31/0G	5	
43232/11/13	111	① 43232/31/0G	5	
43232/17/13	111	① 43232/31/0G	5	
43233/06/13	111	① 43233/31/0G	5	
43233/11/13	111	① 43233/31/0G	5	
43233/17/13	111	① 43233/31/0G	5	
43251/11/13	14	① 43251/31/0G	5	
43251/31/13	15	① 43251/31/0G	5	

Article Pg. Sparepart EAN-number article

45551/17/13	98	① GN059/50/56	5	
45552/30/13	85	① 40364/30/0G	5	
45559/43/13	73	△ 43146/31/0S	5	
55420/11/13	112		5	
55422/11/13	113		5	
55423/11/13	113		5	
55424/11/13	112		5	
55550/31/13	116		5	
55550/48/13	117		5	
55552/31/13	116		5	
55552/48/13	117		5	
55553/31/13	116		5	
55553/48/13	117		5	
55554/31/13	116		5	
55554/48/13	117		5	
55930/17/13	115	① GN049/77/31	5	
55932/17/13	115	① GN049/77/31	5	
55933/17/13	115	① GN049/77/31	5	
55934/17/13	115	① GN049/77/31	5	
55936/17/13	115	① GN049/77/31	5	
67011/17/13	99		5	
67751/17/13	99		5	













**EXPLANATION ON SYMBOLS**



with on/off switch on article



with dimmer on article



article suited for wall & ceiling



with double on/off switch on article



with double dimmer on article



article is equipped with a switch box. By using the on/off switch multiple times, the fixture automatically changes between light sources



with on/off switch on wire



with touch dimmer



with pull switch



with dimmer on wire

**EXPLANATION ON INCLUDED BULBS**



clear bi-pin bulb included



Philips branded G53 bulb included



Philips branded TL-E circular energy saving bulb included



Philips branded clear bi-pin bulb included



Philips branded E14 3U energy saving bulb included



Philips branded 2G11 energy saving bulb included



Philips branded clear G9 bulb included



Philips branded E14 energy saving bulb included



PL-Q energy saving bulb included



Philips branded R7S EcoHalo bulb included



Philips branded E27 3U energy saving bulb included



Philips high Powered LED bulb included



Philips branded GU10 bulb included



Philips branded E27 Tornado energy saving bulb included



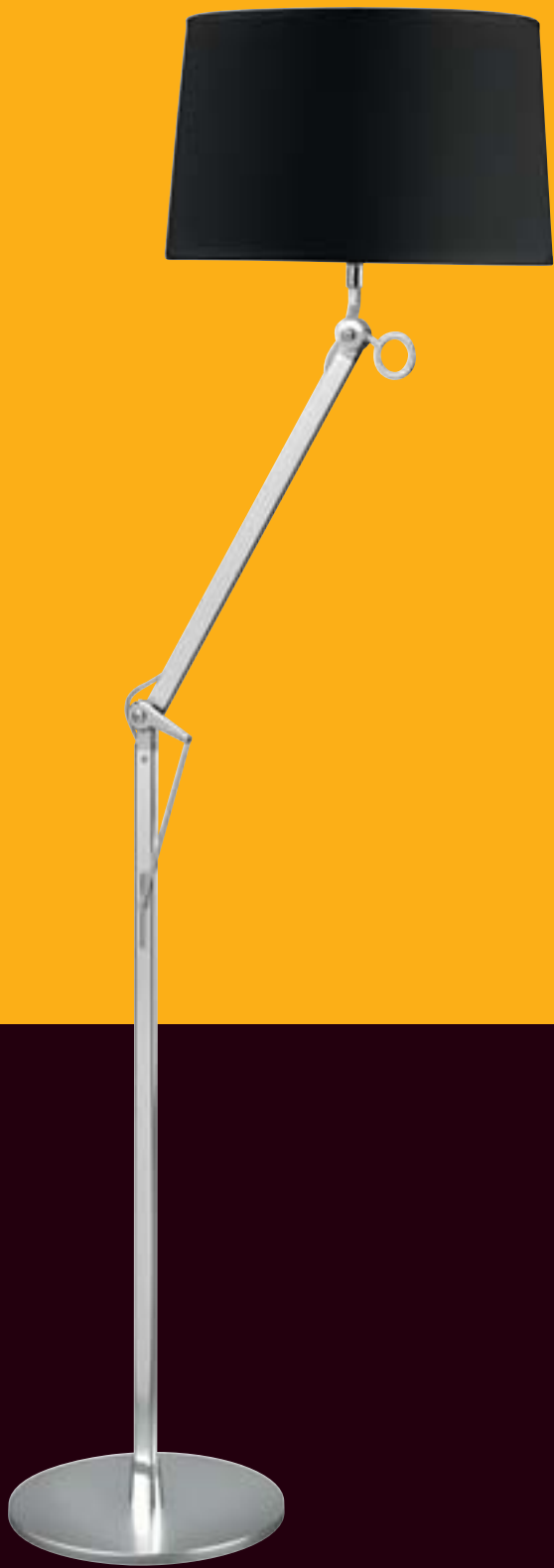

A key brand of Philips Consumer Lighting  
[www.eseo-light.eu](http://www.eseo-light.eu)